

Geiger Keyeira™

Prices effective September 6, 2011

Published April 9, 2012

Terms and Conditions of Sale	2
Limitations and Disclaimers	3
Design Rights	3
Warranty	3
Order Information	3
Website	3
Typical Configurations	4
Specification Notes	6
Options	8
Desks	10
Conference Returns	21
Corner Surface Inserts	21
Corner Units	22
Returns	24
Rear Units	50
Credenzas	62
Machine Tables	70
Bookcases	70
Vertical Storage	71
Wall Mount Storage	74
Wall Mount Tackboards	77
Task Lights	77
Stacking Bookcase	78
Stacking Storage	78
Stacking Storage Tackboards	80
Organizers	81
Grommet	81
Pedestals	82
Low Storage	83
Tops	84
L Panels and Back Panels	84
Index	85

General Information

Terms and Conditions of Sale

GEIGER

Application of Standard Terms

Only the standard terms of sale stated in this catalog apply to any transaction unless those terms are modified or supplemented by a written document signed by an officer of Geiger International, Inc. ("Geiger"). Any terms contained in Customer's purchase order, including standard printed provisions, that are additional to or contrary to these terms, are not effective.

Use of Furniture and Materials

Geiger assumes that textiles, leathers and products are intended for commercial use and are not being bought for use primarily for personal, family, or household purposes. When installed and used as intended, products remain chattel property, are not considered fixtures, and no interest in them should arise under applicable real estate law.

Furniture Prices

Prices are determined by using the published list prices in effect when Geiger receives Customer's completed purchase order. If Customer's requested ship date is more than three months after Geiger receives Customer's order, it may be repriced using the list prices in effect when products ship. If Customer designates special finishes or options, additional charges may apply. Services such as design, project management, packaging, storage, inside delivery, double handling, installation, or inventory management are not included in Geiger's list prices.

COM / COL Procedures

If an order includes Customer-supplied materials, Customer must ship those materials to Geiger at Customer's own expense. The materials must be tagged with Geiger's confirmation number, item number, Customer's name, and purchase order number. Geiger is not liable for inadequacies in Customer's materials. Geiger will notify Customer of any apparent defects in Customer's materials before manufacturing.

Taxes

Customer is responsible for any local sales taxes or other similar taxes imposed on transactions.

Delays

Geiger is not liable for failure to ship by the acknowledged shipping date or any other date. Geiger is not liable for a delay or failure in shipment or performance if the delay or failure is caused by acts of omission of Customer, its agents, employees, contractors, a governmental authority, or God; delays in transportation; or other similar causes that are not within Geiger's reasonable control. Geiger is excused from further performance of its obligations for the duration of a force majeure cause.

Changes and Cancellation

Geiger's acceptance of an order is final and binding and an order may not be changed or canceled without Geiger's written consent.

Orders placed on any of Geiger's expedited shipment programs and orders of custom-dyed or custom-woven materials may not be changed or canceled. To change or cancel other orders, contact Geiger Customer Care in writing for authorization and applicable charges.

Storage

If Customer cannot accept delivery when products are ready, Geiger reserves the right to transfer products to storage and products are invoiced at that time. Customer is responsible for actual storage charges and any other expenses relating to the storage of products or materials that Geiger incurs. Customer bears all risk of loss for products or materials in storage.

Freight Terms

For casegoods and seating orders shipped within the 48 contiguous United States, surface freight charges are included.

For textile and leather orders actual packing and freight charges will be invoiced. Orders are shipped UPS ground unless requested otherwise.

For orders shipped to Alaska or Hawaii, the freight terms stated above apply only to the port of embarkation. Shipments beyond that point are freight collect. Domestic deliveries are shipped FOB Geiger's plant to a destination designated by Customer by a method Geiger selects.

Packaging and Shipping

Geiger's casegoods products are shipped in component form. Shipments over \$50,000 net are blanket wrapped. Tops and panels are shrink wrapped with cardboard corner protection. Pedestals, storage units, overheads and vertical storage units are wrapped in blankets and shrink wrapped with cardboard corner protection. Blankets are to be returned to Geiger for reuse. If the customer request cartoning on orders over \$50,000 net, there will be a charge of five percent of the net order. Packing materials are recyclable.

Shipments under \$50,000 net are cartoned. Cartoned shipments are packaged with a combination of cardboard channels and shrink wrap. Packing materials are recyclable.

Geiger's seating is cartoned in boxes for less than truckload shipments. Full truckload shipments are blanket wrapped.

If Customer requests special shipping or delivery methods, Customer is responsible for any extra costs that result.

Packaging and Shipping (continued)

Customer obtains title to products and materials, and assumes the risk of loss for them, upon shipment from Geiger's plant. Geiger reserves the right to make partial shipments, of truckload quantities, as products are manufactured.

Effective May 2, 2011 Geiger will add a shipping charge to all purchase orders under \$100,000 list. The amount of the shipping charge will be equal to a percentage of the overall list price of the entire order based on the ship to address. These charges will not be discounted.

International Shipping

Orders for export are shipped Ex Works factory (Incoterms 2000). The charge for export packing is five percent of the net order value. There are no export packing charges on shipments to Canada.

Claims

All blanket wrapped shipments must be unwrapped and inspected at the dock, in the presence of the driver. Claims for "concealed damage" or "subject to inspection" will not be honored on blanket wrapped shipments.

All cartoned shipments must be inspected for visual outside damage to the package.

Damages and piece count shortages must be noted on the bill of lading. Freight claims must be filed within 30 days (including cartoned shipments with concealed damage). Contact Customer Care for a warranty/freight claim form and send it by fax, mail or email to:

Geiger International
6095 Fulton Industrial Blvd
Atlanta, GA 30336-0068
Attention: Warranty Department
Fax: 1.404.836.7519
Email: warranty@geigerintl.com

Order Information

Purchase orders should be sent by fax or mailed to:

Geiger International
6095 Fulton Industrial Blvd
Atlanta, GA 30336-0068
Attention: Order Entry
Fax: 1.404.836.7519
Phone: 1.800.456.6452

Warranty

Geiger International, Inc. ("Geiger"), 6095 Fulton Industrial Blvd., SW, Atlanta, GA 30336-0068, USA, warrants the products sold by it to be free from defects in material and workmanship, regardless of the number of shifts during which the products are used, for the warranty periods specified below.

This warranty covers the sale of Geiger product in all countries. Not all of the product lines appearing on this list are marketed by Geiger in all countries, and appearance on this list does not imply an offer for sale of a product line in a particular place. Product line availability is defined in current price lists applicable to different regions.

Geiger Commercial Office Furniture Products

12 years

All products sold under the Geiger® brand name, except as limited or described below.

Textile Alliance ProgramSM Fabrics

3 years

Includes, but is not limited to Luna, Bergamo and True fabrics and Edelman leathers.

IntersectionTM Fabric

3 years

Nonstandard Products

1 to 5 years

Warranty length on nonstandard products not covered by the 12-year warranty is identified on individual product quotes.

All Other Products, Parts, and Services

5 years

Electronic ballasts used in task lighting

3 years

All service parts

6 months

All other products, parts, and any services not listed above, sold or furnished by Geiger, except for consumable products such as light bulbs and other electronic products for which no warranty is given

Other Manufacturers' Products

None

Geiger will pass through to the original purchaser any warranty supplied by other manufacturers to the extent possible, including, but not limited to, open-line laminates.

Provisions that apply to all products and services:

During the applicable warranty period, Geiger, as its sole obligation, will repair or replace (at

Warranty (continued)

its option) any product, part, or component covered by this warranty and sold after the effective date of this warranty, which fails under normal use as a result of a defect in material or workmanship; Geiger will repair or replace the aforementioned product, part, or component with a comparable product, part, or component.

This warranty extends only to the original purchasers who acquire new product from Geiger, or its authorized resellers. Any product, part, or component must have been installed, used, and maintained according to Geiger's published instructions in order to be eligible for coverage under this warranty and must not have been subject to misuse or abuse. Any modification to the original product voids the warranty. Geiger does not warrant the performance of the product when used in combination with other than original Geiger product.

The warranty period starts from the date of purchase.

This document inclusively describes all of the warranties given and remedies available with respect to the company's products and services. Geiger disclaims any other warranty whether express or implied, statutory or otherwise, in relation to the products.

Geiger does not warrant:

- natural variations in wood grain or figure or the presence of character marks
- changes in surface finishes due to aging or exposure to light
- marks, scars, or wrinkles occurring naturally in leather
- veins, marks, voids, fissures, or cracks found naturally in stone

In addition, Geiger does not warrant:

- failure resulting from normal wear and tear
- the matching of colors, grains, or textures of natural materials
- the colorfastness or the matching of colors of textiles, including an exact match to cuttings or to swatch cards
- damage, marking, or staining of veneer surfaces due to contact with rubber or similar compounds; damage from sharp objects or imprinting from writing instruments, or prolonged exposure to direct sunlight

Geiger tests Customer's Own Material (COM) and other customer-supplied items for manufacturing quality only and does not provide any warranty with regard to these materials.

Geiger does not warrant products that are exposed to extreme environmental conditions or that have been subject to improper storage.

Warranty (continued)

Geiger's products meet the requirements of national and specific local codes as stated in the price books and other written publications.

TO THE EXTENT ALLOWED BY LAW, ANY IMPLIED WARRANTIES, INCLUDING ANY WARRANTY OF MERCHANTABILITY OR FITNESS FOR A PARTICULAR PURPOSE, ARE DISCLAIMED AND TO THE EXTENT THEY ARE LEGALLY REQUIRED, ARE LIMITED IN DURATION TO THE DURATION OF THIS WRITTEN WARRANTY.

GEIGER SHALL NOT BE LIABLE FOR LOSS OF TIME, INCONVENIENCE, COMMERCIAL LOSS, OR INCIDENTAL OR CONSEQUENTIAL DAMAGES.

Applies in US only: Some states do not allow limitations on how long an implied warranty lasts or do not allow the exclusion or limitation of incidental or consequential damages, so the limitations or exclusions in the two preceding paragraphs may not apply. This warranty gives the purchaser specific legal rights; however, the purchaser may also have other rights that may vary from state to state.

Applies outside US: Except as stated above, Geiger will not be liable for any loss or damage (including costs) however caused, whether direct or consequential, incurred or suffered by the purchaser or any third party in respect of the products but nothing contained herein will or will be considered to exclude or restrict any liability on Geiger's part for death or personal injury resulting from negligence.

Limitations and Disclaimers

Geiger is not liable for loss of time, inconvenience, lost profits, commercial loss, or other special, consequential, or incidental damages for any transaction.

Geiger reserves the right to change its designs, its methods of construction, or its prices, charges, or policies at any time without notice to Customer.

Design Rights

The designs depicted in Geiger's catalogs and price lists are proprietary to Geiger and Geiger reserves the exclusive right to manufacture them. Any reproduction of these designs infringes Geiger's rights and that infringement will be prosecuted.

Keyeira Typical 1

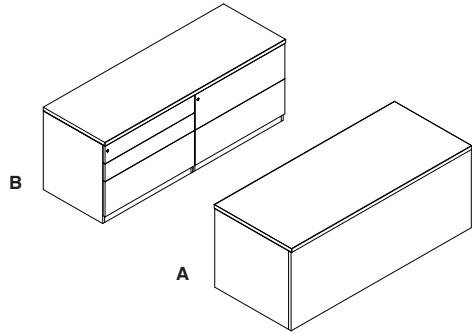

A	TDF9LA4-317229	Keyeira single pedestal desk, 31 x 72	2,807
B	TCRED4D5-257229	Keyeira credenza, 25 x 72	4,132
Keyeira Total List			\$6,939

Keyeira Typical 2

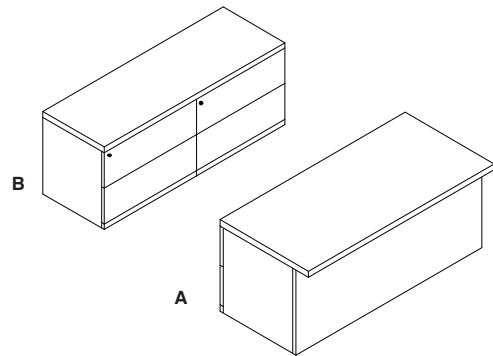

A	TDF6A4A5-377229	Keyeira desk, 37 x 72	3,824
B	TCRED5D5-257229	Keyeira credenza, 25 x 72	4,366
Keyeira Total List			\$8,190

Keyeira Typical 3

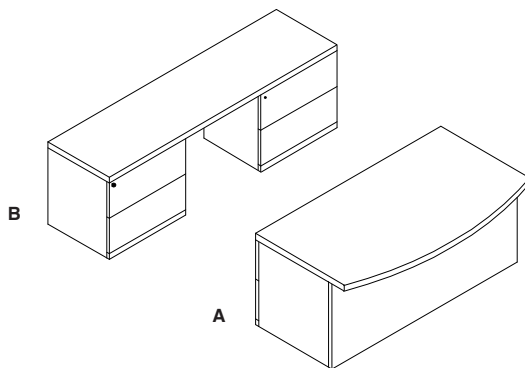

A	TDF8A4A5-437229	Keyeira desk, 43 x 72	4,326
B	TKO1C5C5-259029	Keyeira credenza, 25 x 90	4,249
Keyeira Total List			\$8,575

Keyeira Typical 4

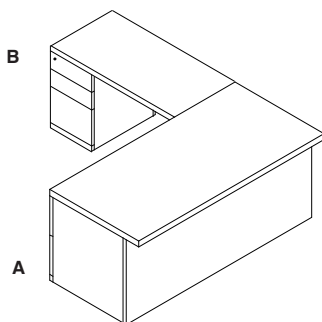

A	TDF5RA4-377229	Keyeira desk, 37 x 72	2,897
B	TLO1LA4-254829	Keyeira open L return, 25 x 48	1,853
Keyeira Total List			\$4,750

Keyeira Typical 5

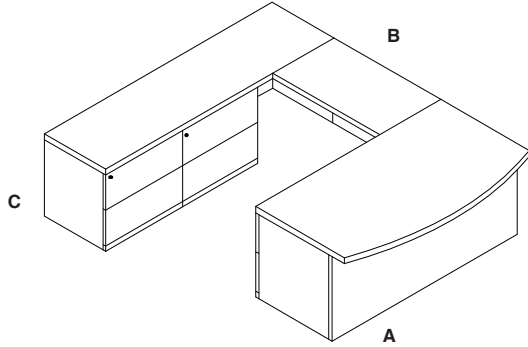

A	TDF7RA4-437229	Keyeira desk, 43 x 72	3,399
B	TUCU-254829	Keyeira closed bridge return, 25 x 48	1,366
C	TROBLC5C5-259629	Keyeira open rear unit, 25 x 96	4,390
Keyeira Total List			\$9,155

Keyeira Typical 6

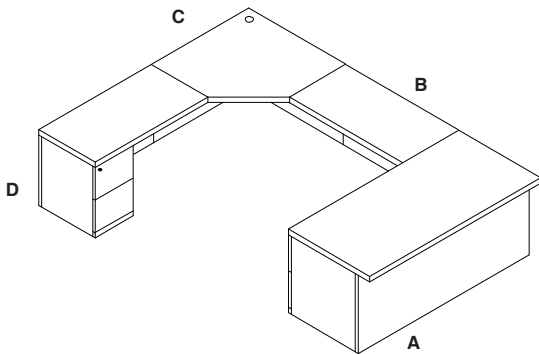

A	TDF5RA4-377229	Keyeira desk, 37 x 72	2,897
B	TUCU-254829	Keyeira closed bridge return, 25 x 48	1,366
C	TCU4-424229	Keyeira corner unit, 42 x 42	2,099
D	TLC1LA5-254829	Keyeira closed L return, 25 x 48	2,343
Keyeira Total List			\$8,705

Keyeira Typical 7

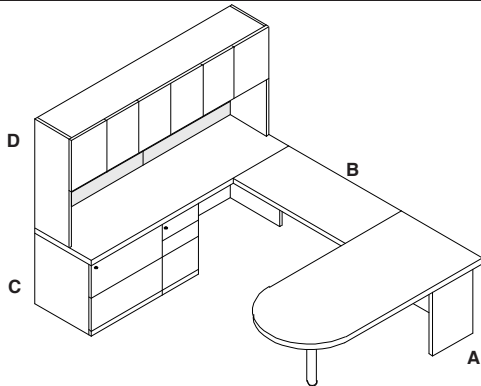

A	TDENR-377229	Keyeira desk, 37 x 72	2,369
B	TUOU-25421	Keyeira open bridge return, 25 x 42	824
C	TROBLC5A4-259029	Keyeira open rear unit, 25 x 90	4,016
D	NU1W-169039	Keyeira stacking storage, 15 5/8 x 90	3,349
D	NFT3-18922	Keyeira two-piece tackboard	567
Keyeira Total List			\$11,125

Keyeira Typical 8

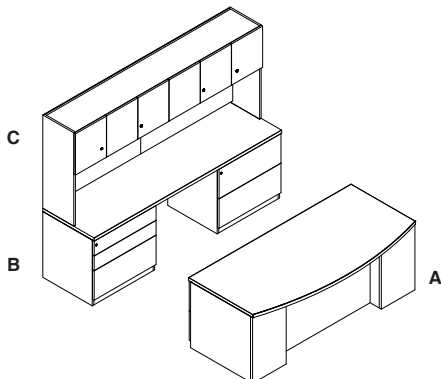

A	TDSEA4A5-377229	Keyeira Desk, 37 x 72	4,263
B	TKO1C4C5-259029	Keyeira open credenza, 25 x 90	3,785
C	NU1W-169039	Keyeira stacking storage, 15 5/8 x 90	3,349
C	NFT3-18922	Keyeira two-piece tackboard	567
Keyeira Total List			\$11,964

How to Specify

- For each product ordered, specify a product number string. The string should include the product number and all finish and detail codes listed at the bottom of the pricebook page under "Specify."
- Specify the finishes and details in the same sequence shown on the pricebook page.
- Product number string example:
 TDF5LA43172 644 N02 G926 LK

The product number string above includes all the required codes for a Keyeira rectangular desk with the following specifications:

Product Number TDF5LA4-3172
 Wood Finish 644 Henna Cherry
 Edge Detail N02 Radius
 Pull GABL, Arc (Black)
 Locks LK Black

General Notes

- Most units ship unassembled; all hardware for assembly is included; tackboards and light fixtures ship uninstalled.
- All tops are 1 3/16" thick. Depth dimensions include 1/4" edge overhang.
- A pencil tray is included in the top box drawer of all pedestals with box drawers.
- Hanging file frames are included in all pedestals and low storage with file drawers. File frames accommodate letter or legal files.
- Locks are available on pedestals, low storage units, vertical storage, wall mount overheads and stacking storage.

Electrical Access Doors

- L returns, rear units and kneespace credenzas with electrical access back panels include a hinged electrical access door, centrally located in the kneespace.

Kneespace Width	Door Width
24" to 31 1/2"	16"
32" to 41 1/2"	24"
42" and wider	30"



Wall Mount Overheads

- Customer should give close attention to the integrity and stability of the wall on which any wall mounted storage is attached. Customer is responsible for the cost of reinforcing or improving its walls, and should involve an architect or engineer where appropriate. Attachment hardware should be securely fastened to the studs in load-bearing walls or in another secure fashion, as the architect or engineer recommends.
- Wall mount overheads are predrilled for black wire dividers; two dividers are included. Additional dividers may be ordered separately from the Tablet™ Casegoods pricebook.

Overheads and Stacking Storage

- Stacking storage is designed to be used above credenzas (Fig. 1) or rear units (Fig. 2).

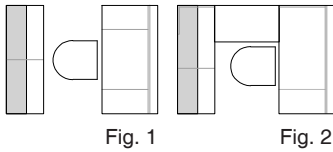

If stacking storage units are required for use across a desk / L return (Fig. 3), or across a desk / bridge return / rear unit (Fig. 4), the overall dimensions of all units must be carefully calculated to ensure proper alignment.

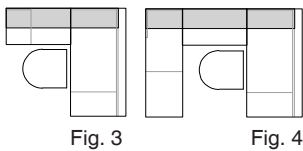

Stacking storage units are designed with side panel support on each end. If the overall width of the stacking storage unit(s) exceeds the total width of the casegoods underneath, the unit will be too wide to be supported as necessary on both ends. For assistance, please contact your Geiger project manager or Customer Care representative at 1.800.456.6452.

- Stacking storage must have adequate pedestal, low storage or panel support under the worksurface.
- Stacking storage units require fabric covered tackboards which should be specified separately.
- Stacking storage units are predrilled for black wire dividers; two dividers are included. Additional dividers may be ordered separately from the Tablet™ Casegoods pricebook.

- Wall mount overheads and stacking storage units are divided and hinged as shown in plan view below.

2 doors (30" and 36" wide)

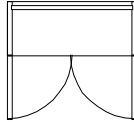

3 doors (42" to 54" wide)

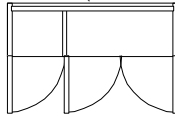

4 doors (60" to 72" wide)

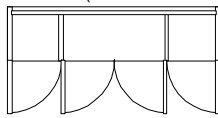

5 doors (78" wide)

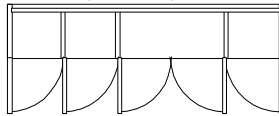

6 doors (84" to 96" wide)

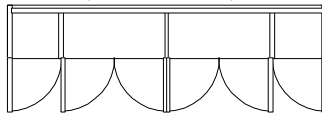

Lock Locations

- Wall mount storage and stacking storage units with hinged doors are available with locks. Lock locations are shown in front elevation below.

2 doors (30" and 36" wide)

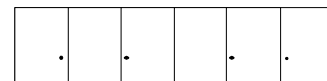
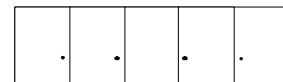
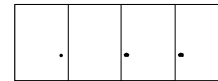
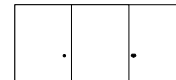
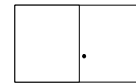

Accessories

Refer to the Tablet™ Casegoods pricebook for the following accessories:

- cable managers
- keyboard mechanisms
- mouse pad
- pencil drawers
- wire dividers

Edge Details
Fabrics
Leg Finishes

Edge Details

- N01 Square
- N02 Radius
- N04 Eased

Notes

All edge details are 1 3/16" thick and match top wood finish.

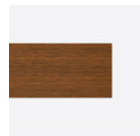

N01 Square Edge



N02 Radius Edge



N04 Eased Edge

Fabrics

Bailey™
(Standard Price Group; no upcharge)

- 7M02 Baxter Beige
- 7M07 Paris Frost
- 7M15 Platinum
- 7M17 Meadow
- 7M18 Cave

Groove™
(Price Group 3; add upcharge shown below)

- 79020 Froth
- 79021 Spring
- 79022 Winter
- 79024 Smoke
- 79030 Rum
- 79031 Marigold
- 79040 Mocha
- 79050 Starlight
- 79060 Mist

Fabric Upcharges *28" to 48" 52" to 96"*
tackboard tackboard

Standard	+\$0	+\$0
Price Group 3	+\$75	+\$150

Leg Finishes

Metal Finish

- 926 Black
- MS Metallic Silver

Locks
Lock Types
LK Black Lock
SK Nickel Lock
NO No Lock

Notes

When locks are specified, lock cylinders must be ordered separately for field installation. There is no charge for lock cylinders. Products will be shipped with lock chassis installed. Lock cylinders will ship separately, tagged as specified. Installation of cylinders will be on-site according to instructions provided. Geiger will not be responsible for lock cylinder installation.

How to Order Lock Cylinders

1. Calculate the total number of locks per office.
2. For each office, order a lock cylinder kit with the required number of cylinders. Use part number PLUG1 (1 cylinder), PLUG2 (2 cylinders), etc. up to PLUG15.
3. Specify cylinder finish X Black or N Nickel.
4. If a specific key number is required, specify a key number between 226 and 427, excluding 408 and 412. For a factory selected key number, specify Z.
5. Include tagging information (floor, office, typical, etc.).

Lock Cylinder Order Example

Part Number	PLUG3
Description	Lock cylinder kit, includes 3 lock cylinders, keyed alike
Options	Lock Finish: X Black Key Number: 233
Tag	Third Floor, Office 300

Pulls
Arc Pull
GABL Black
GAMS ... Metallic Silver

Crescent Pull
7CBL Black
7CMS Metallic Silver

Curved Tab Pull
KTBL Black
KTMS Metallic Silver

Long Tab Pull
5LBL Black
5LMS Metallic Silver

Arc Pull



Crescent Pull



Curved Tab Pull



Long Tab Pull



Wood Finishes
Premium Wood Finishes

Medium Sheen	Low Sheen	
611	911	Champagne Maple
621	921	Champagne Beech
642	942	Sundance Cherry
643	943	Caramel Cherry
644	944	Henna Cherry
646	946	Cocoa Cherry
673	973	Caramel Walnut
674	974	Henna Walnut
676	976	Cocoa Walnut
ED	n/a	Aged Cherry (HMI)
EK	n/a	Med. Red Walnut (HMI)
UL	n/a	Natural Maple (HMI)
UX	n/a	Walnut on Cherry (HMI)

Notes

Geiger beech, cherry, maple and walnut wood veneers are flat-cut and book matched. For products with solid wood edges or legs, the solid wood species used with each type of wood finish is as follows:

Beech finish	maple solid
Cherry finish	cherry solid
Maple finish	maple solid
Walnut finish	walnut solid

Natural wood finishes are unstained to maintain the natural beauty and clarity of the wood. When the veneer and solid wood species are not the same the veneer and solid may differ in color and graining. When a stained wood finish is specified, the solid wood edges are stained to match the veneer top as closely as possible.

Herman Miller finishes may be produced in either low or medium sheen depending on the product specified. The sheen available for each product is listed in the specific option choices.

Keyeira™

Single Pedestal Desks

GEIGER

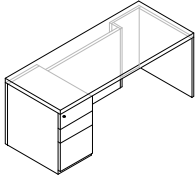
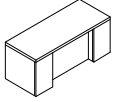
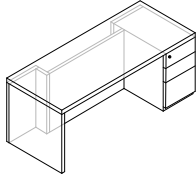
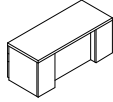
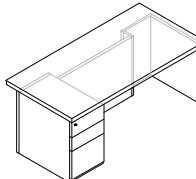
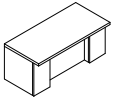
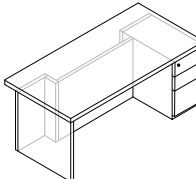
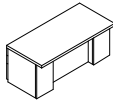
<i>For use with returns</i>	<i>Product Number</i>	<i>Depth</i>	<i>Width</i>	<i>Height</i>	<i>Basic Price</i>
Rectangular • Full Depth Pedestal <i>stepped front, 16 1/8" pedestal</i> <i>left variation</i>	TDS9LA4-316029	31	60	29	\$2,767
	TDS9LA4-316629	31	66	29	2,871
	TDS9LA4-317229	31	72	29	2,961
	TDS9LA4-317829	31	78	29	3,051
					
					
<i>approach side</i>					
Rectangular • Full Depth Pedestal <i>stepped front, 16 1/8" pedestal</i> <i>right variation</i>	TDS9RA4-316029	31	60	29	2,767
	TDS9RA4-316629	31	66	29	2,871
	TDS9RA4-317229	31	72	29	2,961
	TDS9RA4-317829	31	78	29	3,051
					
					
<i>approach side</i>					
Rectangular • Recessed Pedestal <i>stepped front, 16 1/8" pedestal</i> <i>left variation</i>	TDS5LA4-376029	37	60	29	2,859
	TDS5LA4-376629	37	66	29	2,949
	TDS5LA4-377229	37	72	29	3,051
	TDS5LA4-377829	37	78	29	3,154
					
					
<i>approach side</i>					
Rectangular • Recessed Pedestal <i>stepped front, 16 1/8" pedestal</i> <i>right variation</i>	TDS5RA4-376029	37	60	29	2,859
	TDS5RA4-376629	37	66	29	2,949
	TDS5RA4-377229	37	72	29	3,051
	TDS5RA4-377829	37	78	29	3,154
					
					
<i>approach side</i>					

Specify Notes

Product Number

T D S A 4 - 2 9

Wood Edge Pull Lock

page 9 page 8 page 9 page 9

Top edge detail occurs on user and approach side
 Single pedestal desks 60" and 66" wide should not be used with returns
 Stepped front center panels are recessed 5 1/2" from back of pedestals

For use with returns

Rectangular • Full Depth Pedestal
flush front, 16 1/8" pedestal
left variation

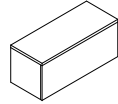
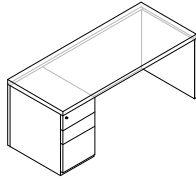

approach side

Product Number	Depth	Width	Height	Basic Price
TDF9LA4-316029	31	60	29	\$2,614
TDF9LA4-316629	31	66	29	2,717
TDF9LA4-317229	31	72	29	2,807
TDF9LA4-317829	31	78	29	2,897

Rectangular • Full Depth Pedestal
flush front, 16 1/8" pedestal
right variation

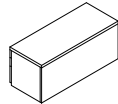
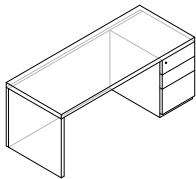

approach side

TDF9RA4-316029	31	60	29	2,614
TDF9RA4-316629	31	66	29	2,717
TDF9RA4-317229	31	72	29	2,807
TDF9RA4-317829	31	78	29	2,897

Rectangular • Recessed Pedestal
flush front, 16 1/8" pedestal
left variation

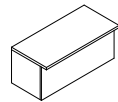
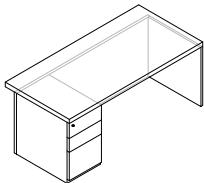

approach side

TDF5LA4-376029	37	60	29	2,703
TDF5LA4-376629	37	66	29	2,794
TDF5LA4-377229	37	72	29	2,897
TDF5LA4-377829	37	78	29	3,001

Rectangular • Recessed Pedestal
flush front, 16 1/8" pedestal
right variation

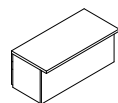
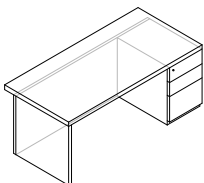

approach side

TDF5RA4-376029	37	60	29	2,703
TDF5RA4-376629	37	66	29	2,794
TDF5RA4-377229	37	72	29	2,897
TDF5RA4-377829	37	78	29	3,001

Specify

Product Number

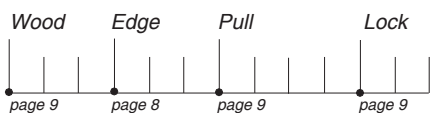

Notes

Top edge detail occurs on user and approach side
Single pedestal desks 60" and 66" wide should not be used with returns

Freestanding

Rectangular • Full Depth Pedestals
stepped front, 16 1/8" pedestals

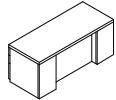
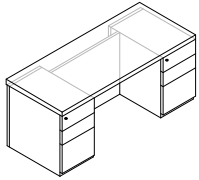

approach side

Product Number	Depth	Width	Height	Basic Price
TDSAA4A4-316029	31	60	29	\$3,618
TDSAA4A4-316629	31	66	29	3,710
TDSAA4A4-317229	31	72	29	3,798
TDSAA4A4-317829	31	78	29	3,876
TDSAA4A4-376029	37	60	29	3,966
TDSAA4A4-376629	37	66	29	4,042
TDSAA4A4-377229	37	72	29	4,145
TDSAA4A4-377829	37	78	29	4,236

Rectangular • Recessed Pedestals
stepped front, 16 1/8" pedestals

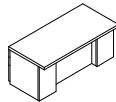
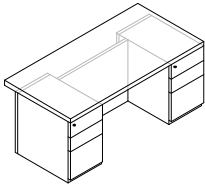

approach side

TDS6A4A4-376029	37	60	29	3,710
TDS6A4A4-376629	37	66	29	3,786
TDS6A4A4-377229	37	72	29	3,888
TDS6A4A4-377829	37	78	29	3,980

Rectangular • Full Depth Pedestals
flush front, 16 1/8" pedestals

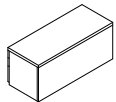
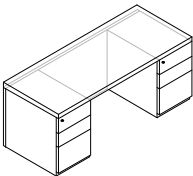

approach side

TDFAA4A4-316029	31	60	29	3,554
TDFAA4A4-316629	31	66	29	3,657
TDFAA4A4-317229	31	72	29	3,734
TDFAA4A4-317829	31	78	29	3,825
TDFAA4A4-376029	37	60	29	3,900
TDFAA4A4-376629	37	66	29	3,990
TDFAA4A4-377229	37	72	29	4,081
TDFAA4A4-377829	37	78	29	4,184

Rectangular • Recessed Pedestals
flush front, 16 1/8" pedestals

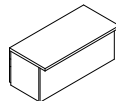
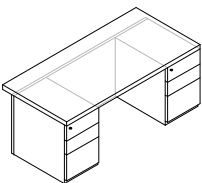

approach side

TDF6A4A4-376029	37	60	29	3,643
TDF6A4A4-376629	37	66	29	3,734
TDF6A4A4-377229	37	72	29	3,824
TDF6A4A4-377829	37	78	29	3,928

Specify

Product Number

T D F A 4 A - 2 9

Wood Edge Pull Lock

page 9 page 8 page 9 page 9

Notes

Top edge detail occurs on user and approach side

Keyeira™

Double Pedestal Desks



Freestanding	Product Number	Depth	Width	Height	Basic Price
Arc Front • Full Depth Pedestals <i>stepped front, 16 1/8" pedestals</i>	TDSEA4A5-376029	37	60	29	\$4,031
	TDSEA4A5-376629	37	66	29	4,134
	TDSEA4A5-377229	37	72	29	4,263

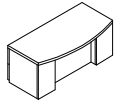
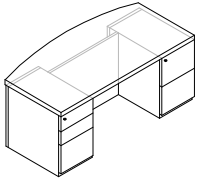

approach side

Arc Front • Recessed Pedestals <i>stepped front, 16 1/8" pedestals</i>	TDS8A4A5-436629	43	66	29	4,263
	TDS8A4A5-437229	43	72	29	4,391
	TDS8A4A5-437829	43	78	29	4,520

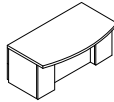
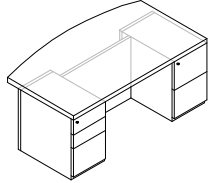

approach side

Arc Front • Full Depth Pedestals <i>stepped front, 16 1/8" pedestals</i>	TDSEA4A4-376029	37	60	29	4,031
	TDSEA4A4-376629	37	66	29	4,134
	TDSEA4A4-377229	37	72	29	4,263

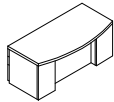
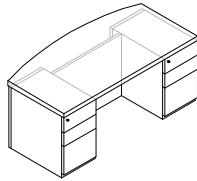

approach side

Arc Front • Recessed Pedestals <i>stepped front, 16 1/8" pedestals</i>	TDS8A4A4-436629	43	66	29	4,263
	TDS8A4A4-437229	43	72	29	4,391
	TDS8A4A4-437829	43	78	29	4,520

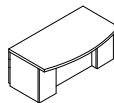
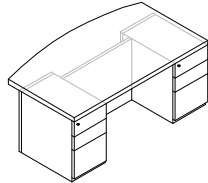

approach side

Specify

Product Number

T D S A 4 A - 2 9

Wood Edge Pull Lock

page 9 page 8 page 9 page 9

Notes

Depth dimension shown is for overall top size (to outside of arc)
Top edge detail occurs on user and approach side
Stepped front desk modesty panels are recessed 5 1/2" from back of pedestals

Freestanding

Arc Front • Full Depth Pedestals
flush front, 16 1/8" pedestals

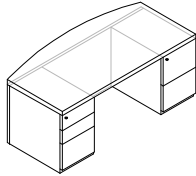

approach side

Product Number	Depth	Width	Height	Basic Price
TDFEA4A5-376029	37	60	29	\$3,966
TDFEA4A5-376629	37	66	29	4,082
TDFEA4A5-377229	37	72	29	4,198

Arc Front • Recessed Pedestals
flush front, 16 1/8" pedestals

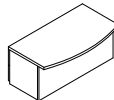
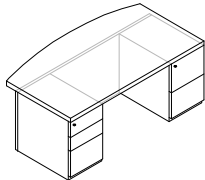

approach side

TDF8A4A5-436629	43	66	29	4,210
TDF8A4A5-437229	43	72	29	4,326
TDF8A4A5-437829	43	78	29	4,470

Arc Front • Full Depth Pedestals
flush front, 16 1/8" pedestals

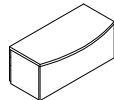
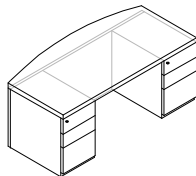

approach side

TDFEA4A4-376029	37	60	29	3,966
TDFEA4A4-376629	37	66	29	4,082
TDFEA4A4-377229	37	72	29	4,198

Arc Front • Recessed Pedestals
flush front, 16 1/8" pedestals

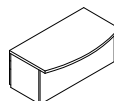
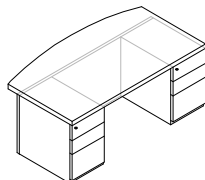

approach side

TDF8A4A4-436629	43	66	29	4,210
TDF8A4A4-437229	43	72	29	4,326
TDF8A4A4-437829	43	78	29	4,470

Specify

Product Number



Wood Edge Pull Lock



Notes

Depth dimension shown is for overall top size (to outside of arc)
Top edge detail occurs on user and approach side

<i>Freestanding or for use with returns</i>	<i>Product Number</i>	<i>Depth</i>	<i>Width</i>	<i>Height</i>	<i>Basic Price</i>
Bullet • L Panel and Leg <i>left variation</i>	TDEML-316029	31	60	29	\$2,150
	TDEML-316629	31	66	29	2,214
	TDEML-317229	31	72	29	2,278

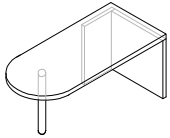

Bullet • L Panel and Leg <i>right variation</i>	TDEMR-316029	31	60	29	2,150
	TDEMR-316629	31	66	29	2,214
	TDEMR-317229	31	72	29	2,278

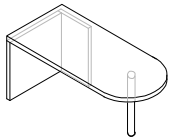

Bullet • L Panel and Leg <i>left variation</i>	TDENL-376629	37	66	29	2,292
	TDENL-377229	37	78	29	2,369
	TDENL-377829	37	78	29	2,447
	TDENL-378429	37	84	29	2,523

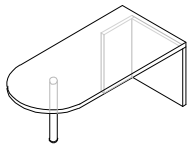

Bullet • L Panel and Leg <i>right variation</i>	TDENR-376629	37	66	29	2,292
	TDENR-377229	37	72	29	2,369
	TDENR-377829	37	78	29	2,447
	TDENR-378429	37	84	29	2,523

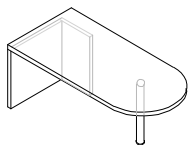

Specify

Product Number

T D E - 2 9

Wood Edge Leg

page 9 page 8 page 8

Notes

Metal leg is 3" diameter

Top edge detail occurs on user and approach side

Freestanding or for use with returns

Bullet • Full Surround
left variation

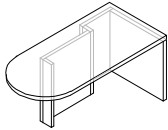

<i>Product Number</i>	<i>Depth</i>	<i>Width</i>	<i>Height</i>	<i>Basic Price</i>
TDEPL-316029	31	60	29	\$2,408
TDEPL-316629	31	66	29	2,536
TDEPL-317229	31	72	29	2,665

Bullet • Full Surround
right variation

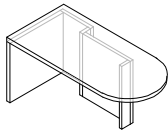

TDEPR-316029	31	60	29	2,408
TDEPR-316629	31	66	29	2,536
TDEPR-317229	31	72	29	2,665

Bullet • Full Surround
left variation

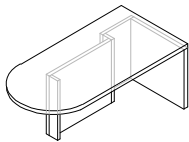

TDEQL-376629	37	66	29	2,589
TDEQL-377229	37	72	29	2,730
TDEQL-377829	37	78	29	2,860
TDEQL-378429	37	84	29	3,001

Bullet • Full Surround
right variation

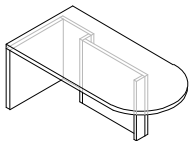

TDEQR-376629	37	66	29	2,589
TDEQR-377229	37	72	29	2,730
TDEQR-377829	37	78	29	2,860
TDEQR-378429	37	84	29	3,001

Specify

Product Number

T D E | | | - | | | | | 2 9

Wood *Edge*

| | | | | | | | | | | | | | | | | | | | | |

page 9 page 8

Notes

Top edge detail occurs on user and approach side

Not for use in a freestanding application

Conference Return
left variation
for use with corner units or straight bridge returns;
not for use with curved bridge returns

Product Number	Depth	Width	Height	Basic Price
TLRBL-485429	48	54	29	\$2,665



Conference Return
right variation
for use with corner units or straight bridge returns;
not for use with curved bridge returns

TLRBR-485429	48	54	29	2,665
---------------------	----	----	----	-------

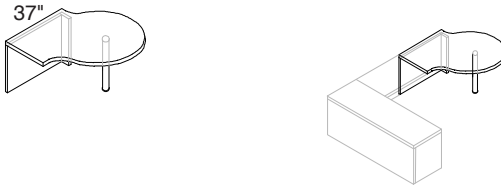

Corner Surface Insert
for use between desks and returns or
between straight bridge returns and rear units

TKS1-12170	12	17	1 1/8	257
-------------------	----	----	-------	-----



Specify

Product Number



Wood Edge Leg (TLRB)



page 9 page 8 page 8

Notes

Top edge detail occurs on user side of conference return and corner insert, and attaching end of conference return

*For attachment to returns;
not for use in a freestanding application*

	Product Number	Depth	Width	Height	Basic Price
Corner Unit • Straight User Side	TCE4-363629	36	36	29	\$2,150
<i>wall access cutouts, for use with returns with electrical access backs</i>	TCE4-424229	42	42	29	2,447

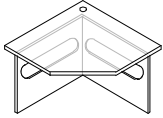

Corner Unit • Curved User Side	TCE5-363629	36	36	29	2,150
<i>wall access cutouts, for use with returns with electrical access backs</i>	TCE5-424229	42	42	29	2,447

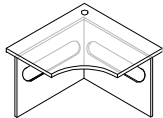

Corner Unit • Straight User Side	TCE6-363629	36	36	29	2,497
<i>wall access cutouts, for use with returns with open or closed backs</i>	TCE6-424229	42	42	29	2,794

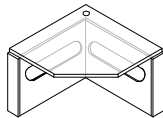

Corner Unit • Curved User Side	TCE7-363629	36	36	29	2,497
<i>wall access cutouts, for use with returns with open or closed backs</i>	TCE7-424229	42	42	29	2,794

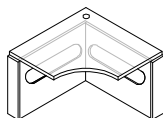

Specify	Notes
<p>Product Number</p> <p>T C E - 2 9</p> <p>Wood Edge</p> <p>page 9 page 8</p>	<p>Top edge detail occurs on user and return sides</p> <p>User side width dimension is 15 1/2" on 36" unit, and 24" on 42" unit</p> <p>Corner units include one factory installed CGK1 black plastic grommet in corner; grommet provides 2 1/4" diameter opening</p>

<i>For use with desks or corner units</i>	<i>Product Number</i>	<i>Depth</i>	<i>Width</i>	<i>Height</i>	<i>Basic Price</i>
L Return • Open Back <i>left variation</i>	TLOSL-253029	25	30	29	\$953
	TLOSL-253629	25	36	29	1,004
	TLOSL-254229	25	42	29	1,056

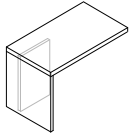

L Return • Open Back <i>right variation</i>	TLOSR-253029	25	30	29	953
	TLOSR-253629	25	36	29	1,004
	TLOSR-254229	25	42	29	1,056

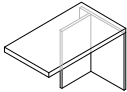

L Return • Closed Back <i>left variation</i>	TLCSL-253029	25	30	29	1,082
	TLCSL-253629	25	36	29	1,184
	TLCSL-254229	25	42	29	1,287

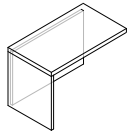

L Return • Closed Back <i>right variation</i>	TLCSR-253029	25	30	29	1,082
	TLCSR-253629	25	36	29	1,184
	TLCSR-254229	25	42	29	1,287

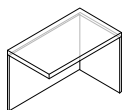

Specify

Product Number

T L S - 2 5 2 9

Wood Edge

page 9 page 8

Notes

Top edge detail occurs on user side and attaching end
Open units are for use against a wall
Closed units include full width finished back panel

For use with desks or corner units

L Return • Electrical Access Back
left variation

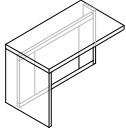

<i>Product Number</i>	<i>Depth</i>	<i>Width</i>	<i>Height</i>	<i>Basic Price</i>
TLESL-253029	25	30	29	\$1,428
TLESL-253629	25	36	29	1,532
TLESL-254229	25	42	29	1,636

L Return • Electrical Access Back
right variation

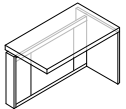

TLESR-253029	25	30	29	1,428
TLESR-253629	25	36	29	1,532
TLESR-254229	25	42	29	1,636

Specify

Product Number

T | L | E | S | | - | 2 | 5 | | | 2 | 9 |

Wood *Edge*



Notes

*Top edge detail occurs on user side and attaching end
Electrical access units are for use against a wall*

<i>For use with desks or corner units</i>	<i>Product Number</i>	<i>Depth</i>	<i>Width</i>	<i>Height</i>	<i>Basic Price</i>
L Return • Open Back <i>16 1/8" pedestal</i> <i>left variation</i>	TLO1LA4-253629	25	36	29	\$1,750
	TLO1LA4-254229	25	42	29	1,801
	TLO1LA4-254829	25	48	29	1,853

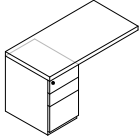

L Return • Open Back <i>16 1/8" pedestal</i> <i>right variation</i>	TLO1RA4-253629	25	36	29	1,750
	TLO1RA4-254229	25	42	29	1,801
	TLO1RA4-254829	25	48	29	1,853

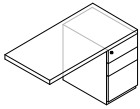

L Return • Closed Back <i>16 1/8" pedestal</i> <i>left variation</i>	TLC1LA4-253629	25	36	29	2,136
	TLC1LA4-254229	25	42	29	2,240
	TLC1LA4-254829	25	48	29	2,343

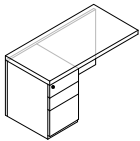

L Return • Closed Back <i>16 1/8" pedestal</i> <i>right variation</i>	TLC1RA4-253629	25	36	29	2,136
	TLC1RA4-254229	25	42	29	2,240
	TLC1RA4-254829	25	48	29	2,343

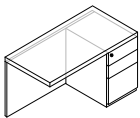

Specify Notes

Product Number

T	L	1	A	4	-	2	5	2	9
---	---	---	---	---	---	---	---	---	---

Wood *Edge* *Pull* *Locks*

•	•	•	•	•	•	•	•	•	•
---	---	---	---	---	---	---	---	---	---

page 9 *page 8* *page 9* *page 9*

Top edge detail occurs on user side and attaching end
Open units are for use against a wall; storage backs are unfinished
Closed units include full width finished back panel

For use with desks or corner units

L Return • Electrical Access Back
 16 1/8" pedestal
 left variation

Product Number	Depth	Width	Height	Basic Price
TLE1LA4-254229	25	42	29	\$2,497
TLE1LA4-254829	25	48	29	2,613

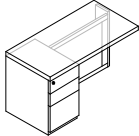

L Return • Electrical Access Back
 16 1/8" pedestal
 right variation

TLE1RA4-254229	25	42	29	2,497
TLE1RA4-254829	25	48	29	2,613

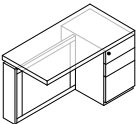

Specify

Product Number

T | L | E | 1 | A | 4 | - | 2 | 5 | | | 2 | 9

Wood | Edge | Pull | Locks

page 9 | page 8 | page 9 | page 9

Notes

Top edge detail occurs on user side and attaching end
 Electrical access units are for use against a wall; storage backs are unfinished

<i>For use with desks or corner units</i>	<i>Product Number</i>	<i>Depth</i>	<i>Width</i>	<i>Height</i>	<i>Basic Price</i>
L Return • Open Back <i>16 1/8" pedestal</i> <i>left variation</i>	TLO1LA5-253629	25	36	29	\$1,750
	TLO1LA5-254229	25	42	29	1,801
	TLO1LA5-254829	25	48	29	1,853

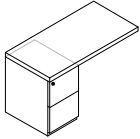

L Return • Open Back <i>16 1/8" pedestal</i> <i>right variation</i>	TLO1RA5-253629	25	36	29	1,750
	TLO1RA5-254229	25	42	29	1,801
	TLO1RA5-254829	25	48	29	1,853

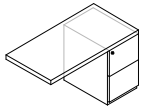

L Return • Closed Back <i>16 1/8" pedestal</i> <i>left variation</i>	TLC1LA5-253629	25	36	29	2,136
	TLC1LA5-254229	25	42	29	2,240
	TLC1LA5-254829	25	48	29	2,343

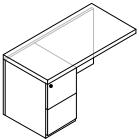

L Return • Closed Back <i>16 1/8" pedestal</i> <i>right variation</i>	TLC1RA5-253629	25	42	29	2,136
	TLC1RA5-254229	25	42	29	2,240
	TLC1RA5-254829	25	48	29	2,343

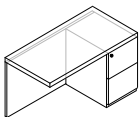

Specify Notes

Product Number

T	L	1	A	5	-	2	5	2	9
---	---	---	---	---	---	---	---	---	---

Wood
Edge
Pull
Locks

page 9	page 8	page 9	page 9
--------	--------	--------	--------

Top edge detail occurs on user side and attaching end
Open units are for use against a wall; storage backs are unfinished
Closed units include full width finished back panel

For use with desks or corner units

	<i>Product Number</i>	<i>Depth</i>	<i>Width</i>	<i>Height</i>	<i>Basic Price</i>
L Return • Electrical Access Back 16 1/8" pedestal left variation	TLE1LA5-254229	25	42	29	\$2,497
	TLE1LA5-254829	25	48	29	2,613

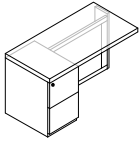

L Return • Electrical Access Back
16 1/8" pedestal
right variation

TLE1RA5-254229	25	42	29	2,497
TLE1RA5-254829	25	48	29	2,613

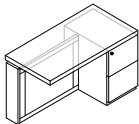

Specify

Product Number

T | L | E | 1 | A | 5 | - | 2 | 5 | | | 2 | 9

Wood Edge Pull Locks

page 9 page 8 page 9 page 9

Notes

*Top edge detail occurs on user side and attaching end
 Electrical access units are for use against a wall; storage backs are unfinished*

<i>For use with desks or corner units</i>	<i>Product Number</i>	<i>Depth</i>	<i>Width</i>	<i>Height</i>	<i>Basic Price</i>
L Return • Open Back	TLO1LC5-254829	25	48	29	\$2,188
30" storage	TLO1LC5-255429	25	54	29	2,251
left variation	TLO1LC5-256029	25	60	29	2,304

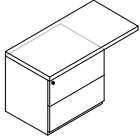

L Return • Open Back	TLO1RC5-254829	25	48	29	2,188
30" storage	TLO1RC5-255429	25	54	29	2,251
right variation	TLO1RC5-256029	25	60	29	2,304

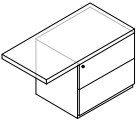

L Return • Closed Back	TLC1LC5-254829	25	48	29	2,678
30" storage	TLC1LC5-255429	25	54	29	2,806
left variation	TLC1LC5-256029	25	60	29	2,910

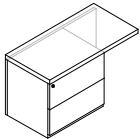

L Return • Closed Back	TLC1RC5-254829	25	48	29	2,678
30" storage	TLC1RC5-255429	25	54	29	2,806
right variation	TLC1RC5-256029	25	60	29	2,910

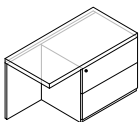

Specify

Product Number

T L 1 C 5 - 2 5 2 9

Wood Edge Pull Locks

page 9 page 8 page 9 page 9

Notes

Top edge detail occurs on user side and attaching end
 Open units are for use against a wall; storage backs are unfinished
 Closed units include full width finished back panel

For use with desks or corner units

L Return • Electrical Access Back
 30" storage
 left variation

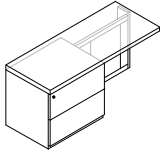

Product Number	Depth	Width	Height	Basic Price
TLE1LC5-255429	25	54	29	\$2,934
TLE1LC5-256029	25	60	29	3,039

L Return • Electrical Access Back
 30" storage
 right variation

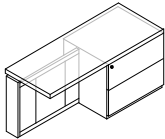

TLE1RC5-255429	25	54	29	2,934
TLE1RC5-256029	25	60	29	3,039

Specify

Product Number

T | L | E | 1 | C | 5 | - | 2 | 5 | | | 2 | 9

Wood Edge Pull Locks

page 9 page 8 page 9 page 9

Notes

Top edge detail occurs on user side and attaching end
 Electrical access units are for use against a wall; storage backs are unfinished

<i>For use with desks or corner units</i>	<i>Product Number</i>	<i>Depth</i>	<i>Width</i>	<i>Height</i>	<i>Basic Price</i>
L Return • Open Back 30" storage, 16 1/8" pedestal left variation	TLO2LC5A4-256029	25	60	29	\$3,527
	TLO2LC5A4-256629	25	66	29	3,578
	TLO2LC5A4-257229	25	72	29	3,630
	TLO2LC5A4-257829	25	78	29	3,682
	TLO2LC5A4-258429	25	84	29	3,733

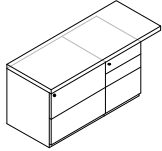

L Return • Open Back 30" storage, 16 1/8" pedestal right variation	TLO2RA4C5-256029	25	60	29	3,527
	TLO2RA4C5-256629	25	66	29	3,578
	TLO2RA4C5-257229	25	72	29	3,630
	TLO2RA4C5-257829	25	78	29	3,682
	TLO2RA4C5-258429	25	84	29	3,733

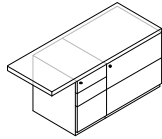

L Return • Closed Back 30" storage, 16 1/8" pedestal left variation	TLC2LC5A4-256029	25	60	29	4,132
	TLC2LC5A4-256629	25	66	29	4,235
	TLC2LC5A4-257229	25	72	29	4,338
	TLC2LC5A4-257829	25	78	29	4,441
	TLC2LC5A4-258429	25	84	29	4,556

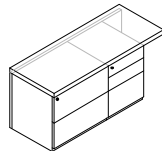

L Return • Closed Back 30" storage, 16 1/8" pedestal right variation	TLC2RA4C5-256029	25	60	29	4,132
	TLC2RA4C5-256629	25	66	29	4,235
	TLC2RA4C5-257229	25	72	29	4,338
	TLC2RA4C5-257829	25	78	29	4,441
	TLC2RA4C5-258429	25	84	29	4,556

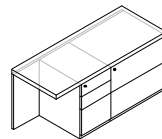

Specify	Notes
<p>Product Number</p> <p>T L 2 - 2 5 2 9</p> <p>Wood Edge Pull Locks</p> <p>page 9 page 8 page 9 page 9</p>	<p>Top edge detail occurs on user side and attaching end</p> <p>Open units are for use against a wall; storage backs are unfinished</p> <p>Closed units include full width finished back panel</p>

<i>For use with desks or corner units</i>	<i>Product Number</i>	<i>Depth</i>	<i>Width</i>	<i>Height</i>	<i>Basic Price</i>
L Return • Open Back 30" storage left variation	TLO2LC5C5-257829	25	78	29	\$4,017
	TLO2LC5C5-258429	25	84	29	4,068
	TLO2LC5C5-259029	25	90	29	4,132
	TLO2LC5C5-259629	25	96	29	4,183

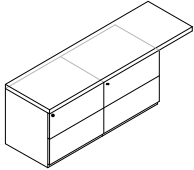

L Return • Open Back 30" storage right variation	TLO2RC5C5-257829	25	78	29	4,017
	TLO2RC5C5-258429	25	84	29	4,068
	TLO2RC5C5-259029	25	90	29	4,132
	TLO2RC5C5-259629	25	96	29	4,183

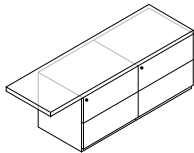

L Return • Closed Back 30" storage left variation	TLC2LC5C5-257829	25	78	29	4,776
	TLC2LC5C5-258429	25	84	29	4,892
	TLC2LC5C5-259029	25	90	29	5,007
	TLC2LC5C5-259629	25	96	29	5,111

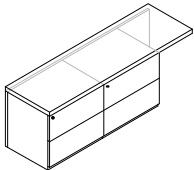

L Return • Closed Back 30" storage right variation	TLC2RC5C5-257829	25	78	29	4,776
	TLC2RC5C5-258429	25	84	29	4,892
	TLC2RC5C5-259029	25	90	29	5,007
	TLC2RC5C5-259629	25	96	29	5,111

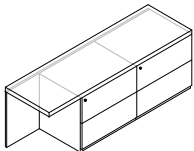

Specify

Product Number

T L 2 C 5 C 5 - 2 5 2 9

Wood Edge Pull Locks

page 9 page 8 page 9 page 9

Notes

Top edge detail occurs on user side and attaching end
Open units are for use against a wall; storage backs are unfinished
Closed units include full width finished back panel

For use with desks or corner units

L Return • Electrical Access Back
 30" storage
 left variation

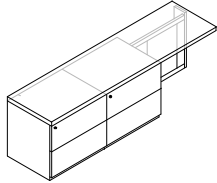

Product Number	Depth	Width	Height	Basic Price
TLE2LC5C5-258429	25	84	29	\$4,750
TLE2LC5C5-259029	25	90	29	4,866
TLE2LC5C5-259629	25	96	29	4,969

L Return • Electrical Access Back
 30" storage
 right variation

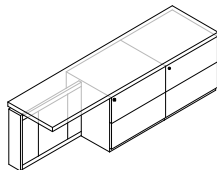

TLE2RC5C5-258429	25	84	29	4,750
TLE2RC5C5-259029	25	90	29	4,866
TLE2RC5C5-259629	25	96	29	4,969

Specify

Product Number

T | L | E | 2 | C | 5 | C | 5 | - | 2 | 5 | 2 | 9

Wood Edge Pull Locks

page 9 page 8 page 9 page 9

Notes

Top edge detail occurs on user side and attaching end
 Electrical access units are for use against a wall; storage backs are unfinished

<i>For use with desks or corner units</i>	<i>Product Number</i>	<i>Depth</i>	<i>Width</i>	<i>Height</i>	<i>Basic Price</i>
L Return • Open Back <i>left variation</i>	TLOTL-253629	25	36	29	\$1,314
	TLOTL-254229	25	42	29	1,365
	TLOTL-254829	25	48	29	1,416

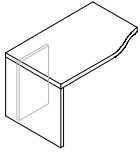

Right end of top is 25" deep; left end is 30" deep

L Return • Open Back <i>right variation</i>	TLOTR-253629	25	36	29	1,314
	TLOTR-254229	25	42	29	1,365
	TLOTR-254829	25	48	29	1,416

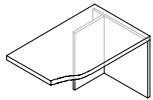

Left end of top is 25" deep; right end is 30" deep

L Return • Closed Back <i>left variation</i>	TLCTL-253629	25	36	29	1,494
	TLCTL-254229	25	42	29	1,595
	TLCTL-254829	25	48	29	1,699

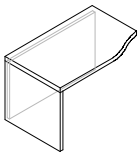

Right end of top is 25" deep; left end is 30" deep

L Return • Closed Back <i>right variation</i>	TLCTR-253629	25	36	29	1,494
	TLCTR-254229	25	42	29	1,595
	TLCTR-254829	25	48	29	1,699

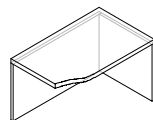

Left end of top is 25" deep; right end is 30" deep

Specify

Product Number

T L T - 2 5 2 9

Wood Edge

page 9 page 8

Notes

Top edge detail occurs on user side and attaching end
Open units are for use against a wall
Closed units include full width finished back panel

For use with desks or corner units

L Return • Electrical Access Back
left variation

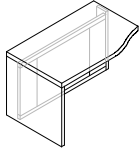

<i>Product Number</i>	<i>Depth</i>	<i>Width</i>	<i>Height</i>	<i>Basic Price</i>
TLETL-253629	25	36	29	\$1,841
TLETL-254229	25	42	29	1,957
TLETL-254829	25	48	29	2,058

Right end of top is 25" deep; left end is 30" deep

L Return • Electrical Access Back
right variation

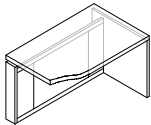

TLETR-253629	25	36	29	1,841
TLETR-254229	25	42	29	1,957
TLETR-254829	25	48	29	2,058

Left end of top is 25" deep; right end is 30" deep

Specify

Product Number

T | L | E | T | | - | 2 | 5 | | | 2 | 9 |

Wood *Edge*



Notes

*Top edge detail occurs on user side and attaching end
Electrical access units are for use against a wall*

<i>For use with desks or corner units</i>	<i>Product Number</i>	<i>Depth</i>	<i>Width</i>	<i>Height</i>	<i>Basic Price</i>
L Return • Open Back 16 1/8" pedestal left variation	TLOALA4-253629	25	36	29	\$2,060
	TLOALA4-254229	25	42	29	2,110
	TLOALA4-254829	25	48	29	2,162

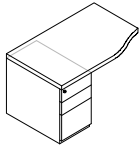

Right end of top is 25" deep; left end is 30" deep

L Return • Open Back 16 1/8" pedestal right variation	TLOARA4-253629	25	36	29	2,060
	TLOARA4-254229	25	42	29	2,110
	TLOARA4-254829	25	48	29	2,162

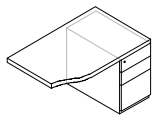

Left end of top is 25" deep; right end is 30" deep

L Return • Closed Back 16 1/8" pedestal left variation	TLCALA4-253629	25	36	29	2,447
	TLCALA4-254229	25	42	29	2,549
	TLCALA4-254829	25	48	29	2,652

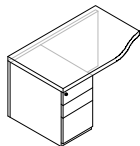

Right end of top is 25" deep; left end is 30" deep

L Return • Closed Back 16 1/8" pedestal right variation	TLCARA4-253629	25	36	29	2,447
	TLCARA4-254229	25	42	29	2,549
	TLCARA4-254829	25	48	29	2,652

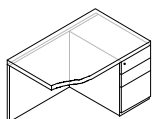

Left end of top is 25" deep; right end is 30" deep

Specify	Notes
---------	-------

<i>Product Number</i>										
T	L	A	A	4	-	2	5		2	9
<i>Wood</i>		<i>Edge</i>		<i>Pull</i>			<i>Locks</i>			
page 9	page 8	page 9	page 9			page 9				

*Top edge detail occurs on user side and attaching end
Open units are for use against a wall; storage backs are unfinished
Closed units include full width finished back panel*

For use with desks or corner units

L Return • Electrical Access Back
 16 1/8" pedestal
 left variation

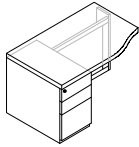

Product Number	Depth	Width	Height	Basic Price
TLEALA4-254229	25	42	29	\$2,807
TLEALA4-254829	25	48	29	2,921

Right end of top is 25" deep; left end is 30" deep

L Return • Electrical Access Back
 16 1/8" pedestal
 right variation

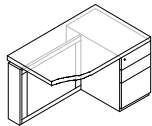

TLEARA4-254229	25	42	29	2,807
TLEARA4-254829	25	48	29	2,921

Left end of top is 25" deep; right end is 30" deep

Specify

Product Number

T L E A A 4 - 2 5 | 2 9

Wood | Edge | Pull | Locks

page 9 | page 8 | page 9 | page 9

Notes

Top edge detail occurs on user side and attaching end
 Electrical access units are for use against a wall; storage backs are unfinished

<i>For use with desks or corner units</i>	<i>Product Number</i>	<i>Depth</i>	<i>Width</i>	<i>Height</i>	<i>Basic Price</i>
L Return • Open Back <i>16 1/8" pedestal</i> <i>left variation</i>	TLOALA5-253629	25	36	29	\$2,060
	TLOALA5-254229	25	42	29	2,110
	TLOALA5-254829	25	48	29	2,162

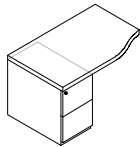

Right end of top is 25" deep; left end is 30" deep

L Return • Open Back <i>16 1/8" pedestal</i> <i>right variation</i>	TLOARA5-253629	25	36	29	2,060
	TLOARA5-254229	25	42	29	2,110
	TLOARA5-254829	25	48	29	2,162

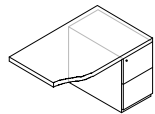

Left end of top is 25" deep; right end is 30" deep

L Return • Closed Back <i>16 1/8" pedestal</i> <i>left variation</i>	TLCALA5-253629	25	36	29	2,447
	TLCALA5-254229	25	42	29	2,549
	TLCALA5-254829	25	48	29	2,652

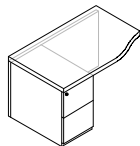

Right end of top is 25" deep; left end is 30" deep

L Return • Closed Back <i>16 1/8" pedestal</i> <i>right variation</i>	TLCARA5-253629	25	36	29	2,447
	TLCARA5-254229	25	42	29	2,549
	TLCARA5-254829	25	48	29	2,652

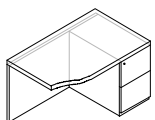

Left end of top is 25" deep; right end is 30" deep

Specify

Product Number

T L A A 5 - 2 5 2 9

Wood Edge Pull Locks

page 9 page 8 page 9 page 9

Notes

*Top edge detail occurs on user side and attaching end
Open units are for use against a wall; storage backs are unfinished
Closed units include full width finished back panel*

For use with desks or corner units

L Return • Electrical Access Back
 16 1/8" pedestal
 left variation

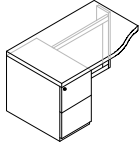

Product Number	Depth	Width	Height	Basic Price
TLEALA5-254229	25	42	29	\$2,807
TLEALA5-254829	25	48	29	2,921

Right end of top is 25" deep; left end is 30" deep

L Return • Electrical Access Back
 16 1/8" pedestal
 right variation

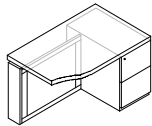

TLEARA5-254229	25	42	29	2,807
TLEARA5-254829	25	48	29	2,921

Left end of top is 25" deep; right end is 30" deep

Specify

Product Number

T | L | E | A | A | 5 | - | 2 | 5 | | | 2 | 9

Wood | Edge | Pull | Locks

page 9 | page 8 | page 9 | page 9

Notes

Top edge detail occurs on user side and attaching end
 Electrical access units are for use against a wall; storage backs are unfinished

<i>For use with desks or corner units</i>	<i>Product Number</i>	<i>Depth</i>	<i>Width</i>	<i>Height</i>	<i>Basic Price</i>
L Return • Open Back 30" storage left variation	TLOALC5-254829	25	48	29	\$2,625
	TLOALC5-255429	25	54	29	2,692
	TLOALC5-256029	25	60	29	2,742

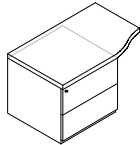

Right end of top is 25" deep; left end is 30" deep

L Return • Open Back 30" storage right variation	TLOARC5-254829	25	48	29	2,625
	TLOARC5-255429	25	54	29	2,692
	TLOARC5-256029	25	60	29	2,742

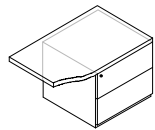

Left end of top is 25" deep; right end is 30" deep

L Return • Closed Back 30" storage left variation	TLCALC5-254829	25	48	29	3,116
	TLCALC5-255429	25	54	29	3,245
	TLCALC5-256029	25	60	29	3,349

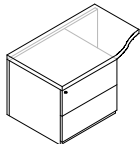

Right end of top is 25" deep; left end is 30" deep

L Return • Closed Back 30" storage right variation	TLCARC5-254829	25	48	29	3,116
	TLCARC5-255429	25	54	29	3,245
	TLCARC5-256029	25	60	29	3,349

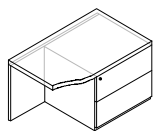

Left end of top is 25" deep; right end is 30" deep

Specify

Product Number

T L A C 5 - 2 5 2 9

Wood Edge Pull Locks

page 9 page 8 page 9 page 9

Notes

Top edge detail occurs on user side and attaching end
Open units are for use against a wall; storage backs are unfinished
Closed units include full width finished back panel

For use with desks or corner units

L Return • Electrical Access Back
 30" storage
 left variation

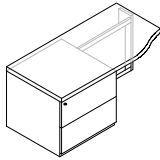

Product Number	Depth	Width	Height	Basic Price
TLEALC5-255429	25	54	29	\$3,372
TLEALC5-256029	25	60	29	3,475

Right end of top is 25" deep; left end is 30" deep

L Return • Electrical Access Back
 30" storage
 right variation

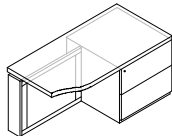

TLEARC5-255429	25	54	29	3,372
TLEARC5-256029	25	60	29	3,475

Left end of top is 25" deep; right end is 30" deep

Specify

Product Number

T L E A C 5 - 2 5 | 2 9

Wood | Edge | Pull | Locks

page 9 | page 8 | page 9 | page 9

Notes

Top edge detail occurs on user side and attaching end
 Electrical access units are for use against a wall; storage backs are unfinished

<i>For use with desks or corner units</i>	<i>Product Number</i>	<i>Depth</i>	<i>Width</i>	<i>Height</i>	<i>Basic Price</i>
L Return • Open Back 30" storage, 16 1/8" pedestal left variation	TLOBLC5A4-256629	25	66	29	\$4,069
	TLOBLC5A4-257229	25	72	29	4,121
	TLOBLC5A4-257829	25	78	29	4,172

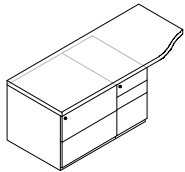

Right end of top is 25" deep; left end is 30" deep

L Return • Open Back 30" storage, 16 1/8" pedestal right variation	TLOBRA4C5-256629	25	66	29	4,069
	TLOBRA4C5-257229	25	72	29	4,121
	TLOBRA4C5-257829	25	78	29	4,172

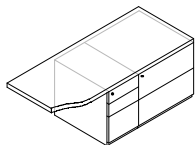

Left end of top is 25" deep; right end is 30" deep

L Return • Closed Back 30" storage, 16 1/8" pedestal left variation	TLCBLC5A4-256629	25	66	29	4,726
	TLCBLC5A4-257229	25	72	29	4,829
	TLCBLC5A4-257829	25	78	29	4,932

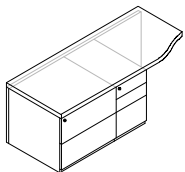

Right end of top is 25" deep; left end is 30" deep

L Return • Closed Back 30" storage, 16 1/8" pedestal right variation	TLCBRA4C5-256629	25	66	29	4,725
	TLCBRA4C5-257229	25	72	29	4,829
	TLCBRA4C5-257829	25	78	29	4,932

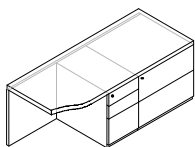

Left end of top is 25" deep; right end is 30" deep

Specify

Product Number

T L B - **2 5** | **2 9**

Wood Edge Pull Locks

page 9 page 8 page 9 page 9

Notes

Top edge detail occurs on user side and attaching end
Open units are for use against a wall; storage backs are unfinished
Closed units include full width finished back panel

<i>For use with desks or corner units</i>	<i>Product Number</i>	<i>Depth</i>	<i>Width</i>	<i>Height</i>	<i>Basic Price</i>
L Return • Open Back 30" storage left variation	TLOBLC5C5-257829	25	78	29	\$4,635
	TLOBLC5C5-258429	25	84	29	4,688
<i>Right end of top is 25" deep; left end is 30" deep</i>					
L Return • Open Back 30" storage right variation	TLOBRC5C5-257829	25	78	29	4,635
	TLOBRC5C5-258429	25	84	29	4,688
<i>Left end of top is 25" deep; right end is 30" deep</i>					
L Return • Closed Back 30" storage left variation	TLCBLC5C5-257829	25	78	29	5,394
	TLCBLC5C5-258429	25	84	29	5,511
<i>Right end of top is 25" deep; left end is 30" deep</i>					
L Return • Closed Back 30" storage right variation	TLCBRC5C5-257829	25	78	29	5,394
	TLCBRC5C5-258429	25	84	29	5,510
<i>Left end of top is 25" deep; right end is 30" deep</i>					

Specify

Product Number

T	L	B	C	5	C	5	-	2	5			2	9
---	---	---	---	---	---	---	---	---	---	--	--	---	---

Wood Edge Pull Locks

page 9	page 8	page 9	page 9
--------	--------	--------	--------

Notes

Top edge detail occurs on user side and attaching end
 Open units are for use against a wall; storage backs are unfinished
 Closed units include full width finished back panel

For use with desks or corner units

L Return • Electrical Access Back
 30" storage
 left variation

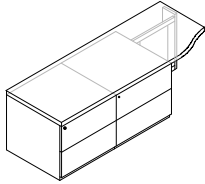

Product Number	Depth	Width	Height	Basic Price
TLEBLC5C5-258429	25	84	29	\$5,369

Right end of top is 25" deep; left end is 30" deep

L Return • Electrical Access Back
 30" storage
 right variation

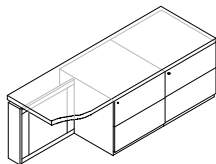

TLEBRC5C5-258429	25	84	29	5,369
-------------------------	----	----	----	-------

Left end of top is 25" deep; right end is 30" deep

Specify

Product Number

T | L | E | B | C | 5 | C | 5 | - | 2 | 5 | 8 | 4 | 2 | 9

Wood | Edge | Pull | Locks

page 9 | page 8 | page 9 | page 9

Notes

*Top edge detail occurs on user side and attaching end
 Electrical access units are for use against a wall; storage backs are unfinished*

For use between desks and corner units or rear units; 24" and 30" wide returns should only be specified for use with corner units

Bridge Return • No Back

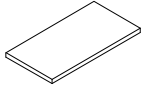

Product Number	Depth	Width	Height	Basic Price
TUOU-25241	25	24	1 1/8	\$671
TUOU-25301	25	30	1 1/8	721
TUOU-25361	25	36	1 1/8	772
TUOU-25421	25	42	1 1/8	824

Bridge Return • Closed Back

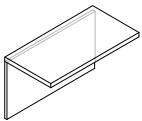

TUCU-252429	25	24	29	940
TUCU-253029	25	30	29	1043
TUCU-253629	25	36	29	1,146
TUCU-254229	25	42	29	1,250
TUCU-254829	25	48	29	1,366

Bridge Return • Electrical Access Back

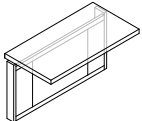

TUEU-252429	25	24	29	1,378
TUEU-253029	25	30	29	1,480
TUEU-253629	25	36	29	1,584
TUEU-254229	25	42	29	1,686
TUEU-254829	25	48	29	1,790

Specify

Product Number



Wood Edge



page 9

page 8

Notes

Top edge detail occurs on user side and attaching ends
Open and electrical access units are designed for use against a wall
Closed units include full width finished back panel

*For use between desks and rear units;
not for use with corner units*

Curved Bridge Return • No Back

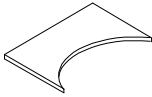

Product Number	Center Depth	End Depth	Width	Height	Basic Price
TUOV-25361	19	25	36	1 1/8	\$1,094
TUOV-25421	19	25	42	1 1/8	1,146
TUOV-31361	25	31	36	1 1/8	1,171
TUOV-31421	25	31	42	1 1/8	1,236

Curved Bridge Return • Closed Back

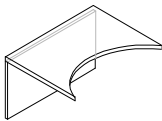

TUCV-253629	19	25	36	29	1,469
TUCV-254229	19	25	42	29	1,572
TUCV-254829	19	25	48	29	1,687
TUCV-313629	25	31	36	29	1,545
TUCV-314229	25	31	42	29	1,661
TUCV-314829	25	31	48	29	1,791

Curved Bridge Return • Electrical Access Back

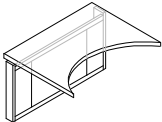

TBEV-313629	25	31	36	29	1,984
TBEV-314229	25	31	42	29	2,099
TBEV-314829	25	31	48	29	2,214

Specify

Product Number

T
V
-

Wood Edge

page 9

page 8

Notes

Top edge detail occurs on user side and attaching ends
Open and electrical access units are designed for use against a wall
Closed units include full width finished back panel

For use with bridge returns and desks to create U configurations

	Product Number	Depth	Width	Height	Basic Price
Rear Unit • Open Back 16 1/8" pedestal left variation	TROALA4-256029	25	60	29	\$2,213
	TROALA4-256629	25	66	29	2,266
	TROALA4-257229	25	72	29	2,317
	TROALA4-257829	25	78	29	2,355

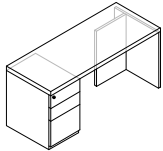

Rear Unit • Open Back 16 1/8" pedestal right variation	TROARA4-256029	25	60	29	2,213
	TROARA4-256629	25	66	29	2,266
	TROARA4-257229	25	72	29	2,317
	TROARA4-257829	25	78	29	2,355

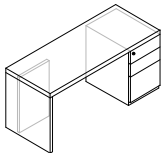

Rear Unit • Closed Back 16 1/8" pedestal left variation	TRCALA4-256029	25	60	29	2,574
	TRCALA4-256629	25	66	29	2,678
	TRCALA4-257229	25	72	29	2,781
	TRCALA4-257829	25	78	29	2,870

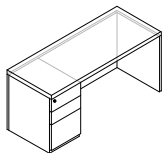

Rear Unit • Closed Back 16 1/8" pedestal right variation	TRCARA4-256029	25	60	29	2,574
	TRCARA4-256629	25	66	29	2,678
	TRCARA4-257229	25	72	29	2,781
	TRCARA4-257829	25	78	29	2,870

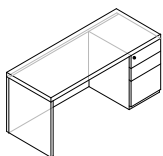

Specify	Notes
<p>Product Number</p> <p>T R A A 4 - 2 5 2 9</p> <p>Wood Edge Pull Locks</p> <p>page 9 page 8 page 9 page 9</p>	<p>Top edge detail occurs on user side</p> <p>Open units are for use against a wall; storage backs are unfinished</p> <p>Closed units include full width finished back panel</p>

For use with bridge returns and desks to create U configurations

Rear Unit • Electrical Access Back
 16 1/8" pedestal
 left variation

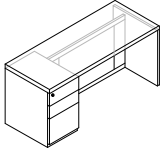

Product Number	Depth	Width	Height	Basic Price
TREALA4-256029	25	60	29	\$2,833
TREALA4-256629	25	66	29	2,935
TREALA4-257229	25	72	29	3,039
TREALA4-257829	25	78	29	3,128

Rear Unit • Electrical Access Back
 16 1/8" pedestal
 right variation

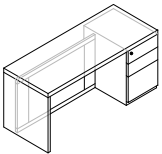

TREARA4-256029	25	60	29	2,833
TREARA4-256629	25	66	29	2,935
TREARA4-257229	25	72	29	3,039
TREARA4-257829	25	78	29	3,128

Specify

Product Number

T R E A A 4 - 2 5 2 9

Wood Edge Pull Locks

page 9 page 8 page 9 page 9

Notes

Top edge detail occurs on user side
 Electrical access units are for use against a wall; storage backs are unfinished

<i>For use with bridge returns and desks to create U configurations</i>	<i>Product Number</i>	<i>Depth</i>	<i>Width</i>	<i>Height</i>	<i>Basic Price</i>
Rear Unit • Open Back 16 1/8" pedestal left variation	TROALA5-256029	25	60	29	\$2,213
	TROALA5-256629	25	66	29	2,266
	TROALA5-257229	25	72	29	2,317
	TROALA5-257829	25	78	29	2,355

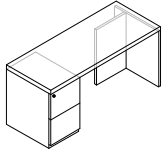

Rear Unit • Open Back 16 1/8" pedestal right variation	TROARA5-256029	25	60	29	2,213
	TROARA5-256629	25	66	29	2,266
	TROARA5-257229	25	72	29	2,317
	TROARA5-257829	25	78	29	2,355

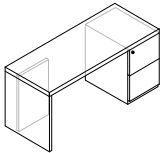

Rear Unit • Closed Back 16 1/8" pedestal left variation	TRCALA5-256029	25	60	29	2,574
	TRCALA5-256629	25	66	29	2,678
	TRCALA5-257229	25	72	29	2,781
	TRCALA5-257829	25	78	29	2,870

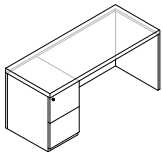

Rear Unit • Closed Back 16 1/8" pedestal right variation	TRCARA5-256029	25	60	29	2,574
	TRCARA5-256629	25	66	29	2,678
	TRCARA5-257229	25	72	29	2,781
	TRCARA5-257829	25	78	29	2,870

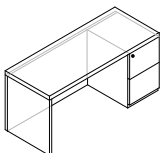

Specify

Product Number

T R A A 5 - 2 5 2 9

Wood Edge Pull Locks

page 9 page 8 page 9 page 9

Notes

Top edge detail occurs on user side

Open units are for use against a wall; storage backs are unfinished

Closed units include full width finished back panel

For use with bridge returns and desks to create U configurations

Rear Unit • Electrical Access Back
 16 1/8" pedestal
 left variation

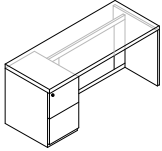

Product Number	Depth	Width	Height	Basic Price
TREALA5-256029	25	60	29	\$2,833
TREALA5-256629	25	66	29	2,935
TREALA5-257229	25	72	29	3,039
TREALA5-257829	25	78	29	3,128

Rear Unit • Electrical Access Back
 16 1/8" pedestal
 right variation

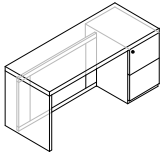

TREARA5-256029	25	60	29	2,833
TREARA5-256629	25	66	29	2,935
TREARA5-257229	25	72	29	3,039
TREARA5-257829	25	78	29	3,128

Specify

Product Number

T R E A A 5 - 2 5 2 9

Wood Edge Pull Locks
 page 9 page 8 page 9 page 9

Notes

Top edge detail occurs on user side
 Electrical access units are for use against a wall; storage backs are unfinished

For use with bridge returns and desks to create U configurations

	Product Number	Depth	Width	Height	Basic Price
Rear Unit • Open Back 30" storage left variation	TROALC5-256629	25	66	29	\$2,601
	TROALC5-257229	25	72	29	2,652
	TROALC5-257829	25	78	29	2,692
	TROALC5-258429	25	84	29	2,742

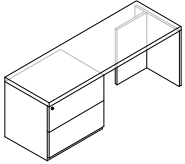

Rear Unit • Open Back 30" storage right variation	TROARC5-256629	25	66	29	2,601
	TROARC5-257229	25	72	29	2,652
	TROARC5-257829	25	78	29	2,692
	TROARC5-258429	25	84	29	2,742

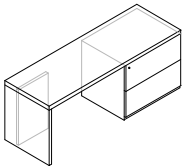

Rear Unit • Closed Back 30" storage left variation	TRCALC5-256629	25	66	29	3,013
	TRCALC5-257229	25	72	29	3,116
	TRCALC5-257829	25	78	29	3,206
	TRCALC5-258429	25	84	29	3,308

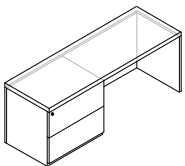

Rear Unit • Closed Back 30" storage right variation	TRCARC5-256629	25	66	29	3,013
	TRCARC5-257229	25	72	29	3,116
	TRCARC5-257829	25	78	29	3,206
	TRCARC5-258429	25	84	29	3,308

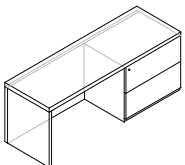

Specify

Product Number

T R A C 5 - 2 5 2 9

Wood Edge Pull Locks

page 9 page 8 page 9 page 9

Notes

Top edge detail occurs on user side
Open units are for use against a wall; storage backs are unfinished
Closed units include full width finished back panel

For use with bridge returns and desks to create U configurations

Rear Unit • Electrical Access Back
 30" storage
 left variation

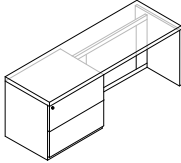

Product Number	Depth	Width	Height	Basic Price
TREALC5-256629	25	66	29	\$3,143
TREALC5-257229	25	72	29	3,258
TREALC5-257829	25	78	29	3,349
TREALC5-258429	25	84	29	3,449

Rear Unit • Electrical Access Back
 30" storage
 right variation

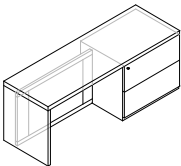

TREARC5-256629	25	66	29	3,143
TREARC5-257229	25	72	29	3,258
TREARC5-257829	25	78	29	3,349
TREARC5-258429	25	84	29	3,449

Specify

Product Number

T R E A C 5 - 2 5 2 9

Wood Edge Pull Locks

page 9 page 8 page 9 page 9

Notes

Top edge detail occurs on user side
 Electrical access units are for use against a wall; storage backs are unfinished

For use with bridge returns and desks to create U configurations

	Product Number	Depth	Width	Height	Basic Price
Rear Unit • Open Back 30" storage, 16 1/8" pedestal left variation	TROBLC5A4-257829	25	78	29	\$3,914
	TROBLC5A4-258429	25	84	29	3,965
	TROBLC5A4-259029	25	90	29	4,016
	TROBLC5A4-259629	25	96	29	4,055

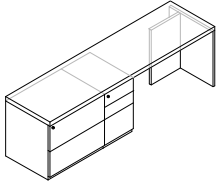

Rear Unit • Open Back 30" storage, 16 1/8" pedestal right variation	TROBRA4C5-257829	25	78	29	3,914
	TROBRA4C5-258429	25	84	29	3,965
	TROBRA4C5-259029	25	90	29	4,016
	TROBRA4C5-259629	25	96	29	4,055

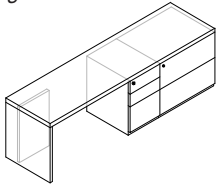

Rear Unit • Closed Back 30" storage, 16 1/8" pedestal left variation	TRCBLC5A4-257829	25	78	29	4,428
	TRCBLC5A4-258429	25	84	29	4,532
	TRCBLC5A4-259029	25	90	29	4,622
	TRCBLC5A4-259629	25	96	29	4,711

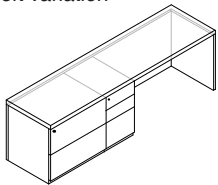

Rear Unit • Closed Back 30" storage, 16 1/8" pedestal right variation	TRCBRA4C5-257829	25	78	29	4,428
	TRCBRA4C5-258429	25	84	29	4,532
	TRCBRA4C5-259029	25	90	29	4,622
	TRCBRA4C5-259629	25	96	29	4,711

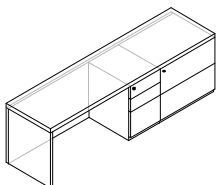

Specify

Product Number

T R B - 2 5 2 9

Wood Edge Pull Locks

page 9 page 8 page 9 page 9

Notes

Top edge detail occurs on user side
Open units are for use against a wall; storage backs are unfinished
Closed units include full width finished back panel

<i>For use with bridge returns and desks to create U configurations</i>	<i>Product Number</i>	<i>Depth</i>	<i>Width</i>	<i>Height</i>	<i>Basic Price</i>
Rear Unit • Open Back 30" storage, 16 1/8" pedestal left variation	TROBLC5A5-257829	25	78	29	\$3,914
	TROBLC5A5-258429	25	84	29	3,965
	TROBLC5A5-259029	25	90	29	4,016
	TROBLC5A5-259629	25	96	29	4,055

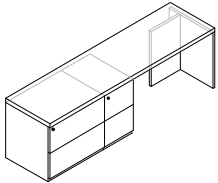

Rear Unit • Open Back 30" storage, 16 1/8" pedestal right variation	TROBRA5C5-257829	25	78	29	3,914
	TROBRA5C5-258429	25	84	29	3,965
	TROBRA5C5-259029	25	90	29	4,016
	TROBRA5C5-259629	25	96	29	4,055

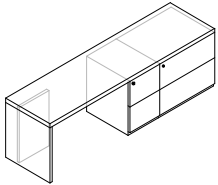

Rear Unit • Closed Back 30" storage, 16 1/8" pedestal left variation	TRCBLC5A5-257829	25	78	29	4,428
	TRCBLC5A5-258429	25	84	29	4,532
	TRCBLC5A5-259029	25	90	29	4,622
	TRCBLC5A5-259629	25	96	29	4,711

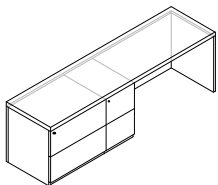

Rear Unit • Closed Back 30" storage, 16 1/8" pedestal right variation	TRCBRA5C5-257829	25	78	29	4,428
	TRCBRA5C5-258429	25	84	29	4,532
	TRCBRA5C5-259029	25	90	29	4,622
	TRCBRA5C5-259629	25	96	29	4,711

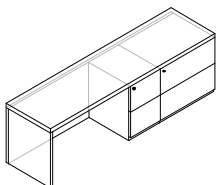

Specify	Notes
<p><i>Product Number</i></p> <p>T R B - 2 5 2 9</p> <p>Wood Edge Pull Locks</p> <p>page 9 page 8 page 9 page 9</p>	<p><i>Top edge detail occurs on user side</i></p> <p><i>Open units are for use against a wall; storage backs are unfinished</i></p> <p><i>Closed units include full width finished back panel</i></p>

<i>For use with bridge returns and desks to create U configurations</i>	<i>Product Number</i>	<i>Depth</i>	<i>Width</i>	<i>Height</i>	<i>Basic Price</i>
Rear Unit • Open Back 30" storage left variation	TROBLC5C5-259029	25	90	29	\$4,350
	TROBLC5C5-259629	25	96	29	4,390

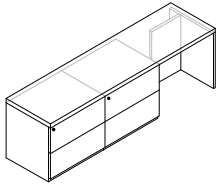

Rear Unit • Open Back 30" storage right variation	TROBRC5C5-259029	25	90	29	4,350
	TROBRC5C5-259629	25	96	29	4,390

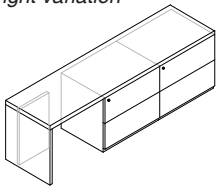

Rear Unit • Closed Back 30" storage left variation	TRCBLC5C5-259029	25	90	29	4,956
	TRCBLC5C5-259629	25	96	29	5,047

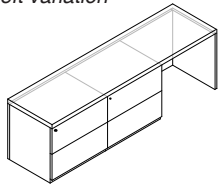

Rear Unit • Closed Back 30" storage right variation	TRCBRC5C5-259029	25	90	29	4,956
	TRCBRC5C5-259629	25	96	29	5,047

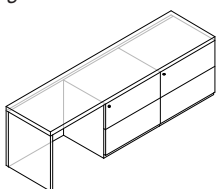

Specify	Notes
---------	-------

Product Number

T	R	B	C	5	C	5	-	2	5			2	9
---	---	---	---	---	---	---	---	---	---	--	--	---	---

Wood Edge Pull Locks

•	•	•	•
---	---	---	---

page 9 page 8 page 9 page 9

Top edge detail occurs on user side
 Open units are for use against a wall; storage backs are unfinished
 Closed units include full width finished back panel

For use with bridge returns and desks to create U configurations

	Product Number	Depth	Width	Height	Basic Price
--	----------------	-------	-------	--------	-------------

Rear Unit • Electrical Access Back
30" storage
left variation

TREBLC5C5-259029	25	90	29	\$4,840
TREBLC5C5-259629	25	96	29	4,932

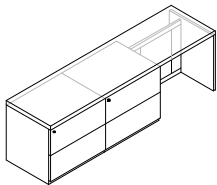

Rear Unit • Electrical Access Back
30" storage
right variation

TREBRC5C5-259029	25	90	29	4,840
TREBRC5C5-259629	25	96	29	4,932

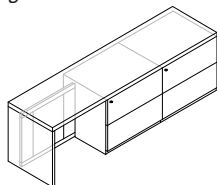

Specify

Product Number

T	R	E	B	C	5	C	5	-	2	5			2	9
---	---	---	---	---	---	---	---	---	---	---	--	--	---	---

Wood Edge Pull Locks

page 9	page 8	page 9	page 9											

Notes

Top edge detail occurs on user side
Electrical access units are for use against a wall; storage backs are unfinished

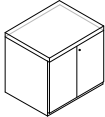
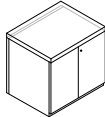
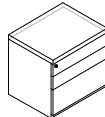
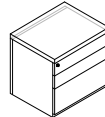
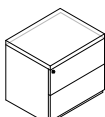
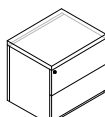
Freestanding	Product Number	Depth	Width	Height	Basic Price
Credenza 30" or 36" storage	TCRDC2-253029	25	30	29	\$1,777
	TCRDD2-253629	25	36	29	1,893
  unfinished back finished back	<i>finished back</i>				
	TCFDC2-253029	25	30	29	2,085
	TCFDD2-253629	25	36	29	2,252
<hr/>					
Credenza 30" or 36" storage	TCRDC4-253029	25	30	29	1,919
	TCRDD4-253629	25	36	29	2,086
  unfinished back finished back	<i>finished back</i>				
	TCFDC4-253029	25	30	29	2,228
	TCFDD4-253629	25	36	29	2,447
<hr/>					
Credenza 30" or 36" storage, anti-tilt mechanism and counterweights	TCRDC5-253029	25	30	29	2,150
	TCRDD5-253629	25	36	29	2,318
  unfinished back finished back	<i>finished back</i>				
	TCFDC5-253029	25	30	29	2,459
	TCFDD5-253629	25	36	29	2,678

Specify

Product Number

T C D - 2 5 2 9

Wood Edge Pull Locks

page 9 page 8 page 9 page 9

Notes

Top edge detail occurs on user side

Credenzas with finished backs include full width finished back panel

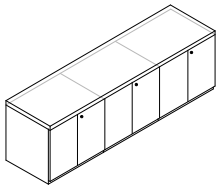
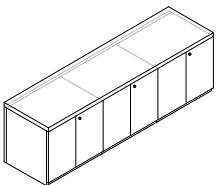
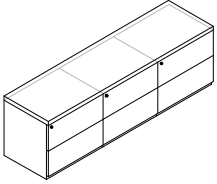
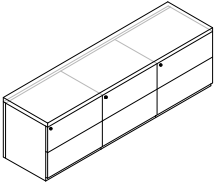
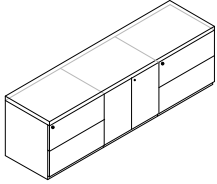
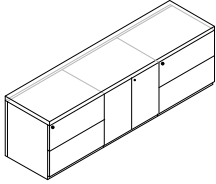
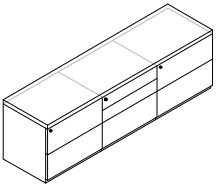
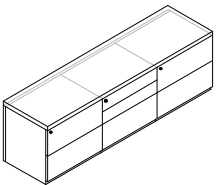
Freestanding	Product Number	Depth	Width	Height	Basic Price
Credenza 30" storage 90" 30" • 30" • 30"	TCRFC2C2C2-259029	25	90	29	\$4,916
	finished back TCFFC2C2C2-259029	25	90	29	5,729
 unfinished back	 finished back				
Credenza 30" storage, anti-tilt mechanism and counterweights 90" 30" • 30" • 30"	TCRFC5C5C5-259029	25	90	29	6,038
	finished back TCFFC5C5C5-259029	25	90	29	6,850
 unfinished back	 finished back				
Credenza anti-tilt mechanism and counterweights 30" storage 90" 30" • 30" • 30"	TCRFC5C2C5-259029	25	90	29	5,664
	finished back TCFFC5C2C5-259029	25	90	29	6,476
 unfinished back	 finished back				
Credenza 30" storage, anti-tilt mechanism and counterweights 90" 30" • 30" • 30"	TCRFC5C4C5-259029	25	90	29	5,807
	finished back TCFFC5C4C5-259029	25	90	29	6,618
 unfinished back	 finished back				

Specify

Product Number

T	C	F	C	C	C	-	2	5	9	0	2	9
---	---	---	---	---	---	---	---	---	---	---	---	---

Wood Edge Pull Locks

•	•	•	•	•	•	•	•	•	•	•	•	•
---	---	---	---	---	---	---	---	---	---	---	---	---

page 9 page 8 page 9 page 9

Notes

Top edge detail occurs on user side
 Credenzas with finished backs include full width finished back panel

Freestanding	Product Number	Depth	Width	Height	Basic Price
Credenza • Open Back unfinished back 16 1/8" pedestals	TKO1A5A5-256029	25	60	29	\$3,038
	TKO1A5A5-256629	25	66	29	3,090
	TKO1A5A5-257229	25	72	29	3,142

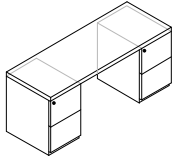

Credenza • Closed Back finished back 16 1/8" pedestals	TKC1A5A5-256029	25	60	29	3,605
	TKC1A5A5-256629	25	66	29	3,709
	TKC1A5A5-257229	25	72	29	3,797
	TKC1A5A5-257829	25	78	29	3,887

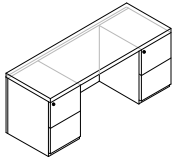

Credenza • Electrical Access Back unfinished back 16 1/8" pedestals	TKE1A5A5-256029	25	60	29	3,656
	TKE1A5A5-256629	25	66	29	3,772
	TKE1A5A5-257229	25	72	29	3,875
	TKE1A5A5-257829	25	78	29	3,965

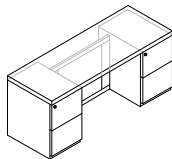

Specify

Product Number

T K | 1 A 5 A 5 | - 2 5 | | | 2 9

Wood | Edge | Pull | Locks

page 9 | page 8 | page 9 | page 9

Notes

Top edge detail occurs on user side
Credenzas with finished backs include full width finished back panel

<i>Freestanding</i>	<i>Product Number</i>	<i>Depth</i>	<i>Width</i>	<i>Height</i>	<i>Basic Price</i>
Credenza • Open Back <i>unfinished back</i> <i>30" storage</i>	TKO1C4C5-259029	25	90	29	\$3,785
	TKO1C4C5-259629	25	96	29	3,824

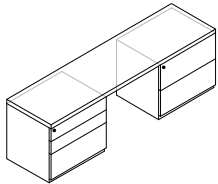

Credenza • Closed Back <i>finished back</i> <i>30" storage</i>	TKC1C4C5-259029	25	90	29	4,596
	TKC1C4C5-259629	25	96	29	4,687

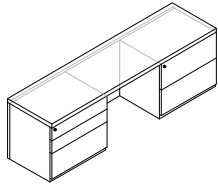

Credenza • Electrical Access Back <i>unfinished back</i> <i>30" storage</i>	TKE1C4C5-259029	25	90	29	4,429
	TKE1C4C5-259629	25	96	29	4,519

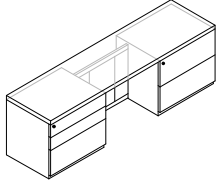

Specify

Product Number

T
K
1
C
4
C
5
-
2
5

2
9

Wood *Edge* *Pull* *Locks*

page 9 *page 8* *page 9* *page 9*

Notes

Top edge detail occurs on user side
Credenzas with finished backs include full width finished back panel

Freestanding	Product Number	Depth	Width	Height	Basic Price
Credenza • Open Back unfinished back 30" storage	TKO1C5C5-259029	25	90	29	\$4,249
	TKO1C5C5-259629	25	96	29	4,287

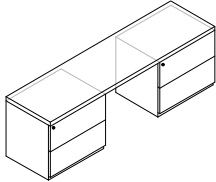

Credenza • Closed Back finished back 30" storage	TKC1C5C5-259029	25	90	29	5,059
	TKC1C5C5-259629	25	96	29	5,150

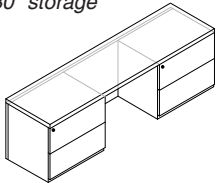

Credenza • Electrical Access Back unfinished back 30" storage	TKE1C5C5-259029	25	90	29	4,893
	TKE1C5C5-259629	25	96	29	4,982

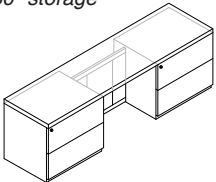

Specify

Product Number

T	K	1	C	5	C	5	-	2	5			2	9
---	---	---	---	---	---	---	---	---	---	--	--	---	---

Wood Edge Pull Locks

--	--	--	--	--	--	--	--	--	--	--	--	--	--

page 9 page 8 page 9 page 9

Notes

Top edge detail occurs on user side
Credenzas with finished backs include full width finished back panel

<i>Freestanding; open bookcases; not for use on top of rear units or credenzas</i>	<i>Product Number</i>	<i>Depth</i>	<i>Width</i>	<i>Height</i>	<i>Basic Price</i>
Machine Table <i>with casters, adjustable top shelf, fixed bottom shelf, and horizontal wiring space above back panel</i>	TMTE-253029	25	30	29	\$1,647
	TMTE-253629	25	36	29	1,828



Bookcase • Finished Top <i>with one adjustable shelf (accommodates one row of 12" binders)</i>	TBCA-143028	14	30	28	1,056
	TBCA-143628	14	36	28	1,159

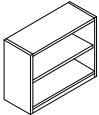

Bookcase • Finished Top <i>with two adjustable shelves</i>	TBCA-143044	14	30	44	1,416
	TBCA-143644	14	36	44	1,545

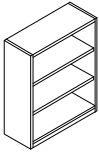

Bookcase • Finished Top <i>with two adjustable shelves, one fixed shelf</i>	TBCA-143068	14	30	68	1,867
	TBCA-143668	14	36	68	2,022

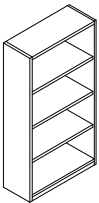

fixed shelf

Specify

Product Number



Wood *Edge**



page 9

page 8

Notes

**Required only on machine table
Machine table tops include edge detail on user side
Machine table backs are finished
Bookcase backs are unfinished*

<i>Freestanding</i>	<i>Product Number</i>	<i>Depth</i>	<i>Width</i>	<i>Height</i>	<i>Basic Price</i>
---------------------	-----------------------	--------------	--------------	---------------	--------------------

Vertical Storage • Wardrobe
hinge on left

TVSP-251668

25 16 68 \$2,034

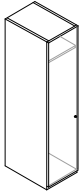

Vertical Storage • Wardrobe
hinge on right

TVSQ-251668

25 16 68 2,034

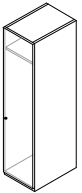

Vertical Storage • Shelves
hinge on left

TVSR-251668

25 16 68 2,394

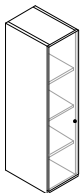

Vertical Storage • Shelves
hinge on right

TVSS-251668

25 16 68 2,394

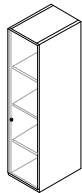

Specify

Product Number

T V S - 2 5 1 6 6 8

Wood Pull Locks

page 9 page 9 page 9

Notes

Vertical storage unit backs are unfinished
Vertical storage units include adjustable shelves

<i>Freestanding</i>	<i>Product Number</i>	<i>Depth</i>	<i>Width</i>	<i>Height</i>	<i>Basic Price</i>
Vertical Storage • 2 Files Below Door <i>hinge on left</i>	TVSK-251668	25	16	68	\$3,065

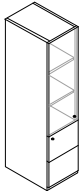

Vertical Storage • 2 Files Below Door <i>hinge on right</i>	TVSL-251668	25	16	68	3,065
---	--------------------	----	----	----	-------

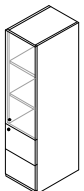

Vertical Storage • 3 Files Below Door <i>hinge on left</i>	TVSM-251668	25	16	68	3,065
--	--------------------	----	----	----	-------

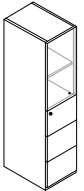

Vertical Storage • 3 Files Below Door <i>hinge on right</i>	TVSN-251668	25	16	68	3,065
---	--------------------	----	----	----	-------

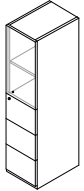

Specify

Product Number

T V S - 2 5 1 6 6 8

Wood

Pull

Locks

page 9 page 9 page 9

Notes

Vertical storage unit backs are unfinished
Vertical storage units include adjustable shelves

<i>Freestanding</i>	<i>Product Number</i>	<i>Depth</i>	<i>Width</i>	<i>Height</i>	<i>Basic Price</i>
Vertical Storage • Shelves	TVS7-253068	25	30	68	\$3,425
	TVS7-253668	25	36	68	3,579

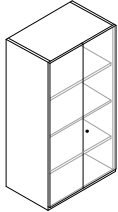

Vertical Storage • Wardrobe / Shelves	TVS6-253068	25	30	68	3,657
	TVS6-253668	25	36	68	3,812

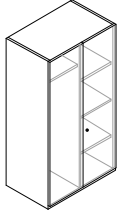

Vertical Storage • 2 Files Below Doors	TVS3-253068	25	30	68	4,299
	TVS3-253668	25	36	68	4,596

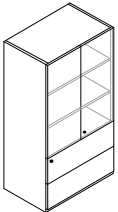

Vertical Storage • 3 Files Below Doors	TVS4-253068	25	30	68	4,481
	TVS4-253668	25	36	68	4,763

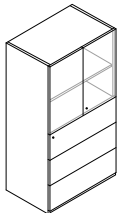

Specify

Product Number

T V S - 2 5 3 6 8

Wood

Pull

Locks

page 9 page 9 page 9

Notes

Vertical storage unit backs are unfinished

Vertical storage units include adjustable shelves

<i>For attachment to wall; must be attached to studs in load-bearing wall</i>	<i>Product Number</i>	<i>Depth</i>	<i>Width</i>	<i>Height</i>	<i>Basic Price</i>
Wall Mount Storage • Open	NWO2-153017	15	30	17	\$1,082
	NWO2-153617	15	36	17	1,145

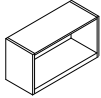

Wall Mount Storage • Open	NWO2-154217	15	42	17	1,287
	NWO2-154817	15	48	17	1,365
	NWO2-155417	15	54	17	1,455

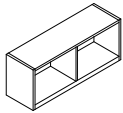

Wall Mount Storage • Open	NWO2-156017	15	60	17	1,596
	NWO2-156617	15	66	17	1,674
	NWO2-157217	15	72	17	1,739

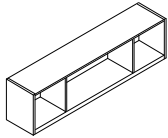

Wall Mount Storage • Open	NWO2-157817	15	78	17	1,841
	NWO2-158417	15	84	17	1,919
	NWO2-159017	15	90	17	2,137
	NWO2-159617	15	96	17	2,201

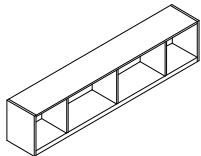

Specify

Product Number

Wood

page 9

Notes

Wall mount storage backs are unfinished
Task light fixtures may be specified separately; see page 107

For attachment to wall; must be attached to studs in load-bearing wall

Wall Mount Storage • Door / Open / Door

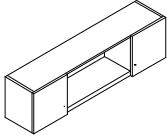

<i>Product Number</i>	<i>Depth</i>	<i>Width</i>	<i>Height</i>	<i>Basic Price</i>
NWO3-164817	16	48	17	\$1,725
NWO3-165417	16	54	17	1,816
NWO3-166017	16	60	17	1,957
NWO3-166617	16	66	17	2,034
NWO3-167217	16	72	17	2,099

Wall Mount Storage • Door / Open / Door

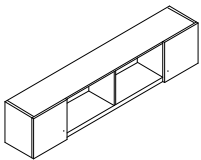

NWO3-167817	16	78	17	2,201
NWO3-168417	16	84	17	2,278
NWO3-169017	16	90	17	2,497
NWO3-169617	16	96	17	2,562

Specify

Product Number

N	W	O	3	-	1	6			1	7
---	---	---	---	---	---	---	--	--	---	---

Wood

Locks

--	--	--	--	--	--

page 9

page 9

Notes

*Wall mount storage backs are unfinished
 Task light fixtures may be specified separately; see page 107*

For attachment to wall; must be attached to studs in load-bearing wall

	<i>Product Number</i>	<i>Depth</i>	<i>Width</i>	<i>Height</i>	<i>Basic Price</i>
Wall Mount Storage • Doors	NWO1-163017	16	30	17	\$1,416
	NWO1-163617	16	36	17	1,480

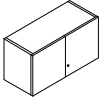

Wall Mount Storage • Doors	NWO1-164217	16	42	17	1,790
	NWO1-164817	16	48	17	1,867
	NWO1-165417	16	54	17	1,957

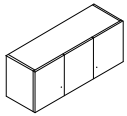

Wall Mount Storage • Doors	NWO1-166017	16	60	17	2,162
	NWO1-166617	16	66	17	2,240
	NWO1-167217	16	72	17	2,304

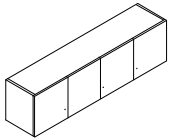

Wall Mount Storage • Doors	NWO1-167817	16	78	17	2,549
-----------------------------------	--------------------	----	----	----	-------

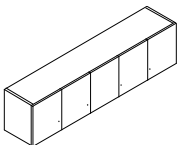

Wall Mount Storage • Doors	NWO1-168417	16	84	17	2,767
	NWO1-169017	16	90	17	2,987
	NWO1-169617	16	96	17	3,051

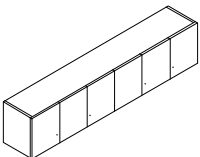

Specify

Product Number

N W O 1 - 1 6 | 1 7

Wood

Locks

| | | | | | | | | |

page 9

page 9

Notes

Wall mount storage backs are unfinished

Task light fixtures may be specified separately; see page 107

	Product Number	Depth	Width	Height	Basic Price
Wall Mount Tackboard • One-Piece Concealed Wire Managers Left and Right	NFT5-13022	1	24	22	\$271
	NFT5-13622	1	30	22	283
	NFT5-14222	1	36	22	283
	NFT5-14522	1	42	22	296
	NFT5-14822	1	48	22	296

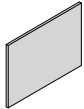

*Pricing shown includes fabric in Standard price group
Additional upcharges apply for other price groups*

Wall Mount Tackboard • Two-Piece Concealed Wire Managers Left and Right	NFT6-15422	1	54	22	490
	NFT6-16022	1	60	22	515
	NFT6-16622	1	66	22	515
	NFT6-17222	1	72	22	567
	NFT6-17822	1	78	22	567
	NFT6-18422	1	84	22	567
	NFT6-19022	1	90	22	593
NFT6-19622	1	96	22	593	

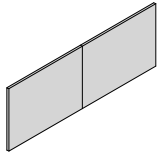

*Pricing shown includes fabric in Standard price group
Additional upcharges apply for other price groups*

Task Lights	for use in U.S. (except Chicago)		Storage Width		Light Width		
	Product Number	Depth	Width	Height	Width	Height	
	DD715-7302	30	7	26	2	309	
	DD715-7362	36	7	26	2	309	
	DD715-7422	42	7	38	2	336	
	DD715-7452	45	7	38	2	336	
	DD715-7482	48	7	38	2	336	
	DD715-7542	54	7	38	2	336	
	DD715-7602	60	7	44	2	336	
	DD715-7662	66	7	56	2	336	
	DD715-7722	72	7	62	2	413	
	DD715-7782	78	7	62	2	413	
	DD715-7842	84	7	38/38	2	483	

for use in Chicago

DD711-7302	30	7	26	2	309
DD711-7362	36	7	26	2	309
DD711-7422	42	7	38	2	336
DD711-7452	45	7	38	2	336
DD711-7482	48	7	38	2	336
DD711-7542	54	7	38	2	336
DD711-7602	60	7	44	2	336
DD711-7662	66	7	56	2	336
DD711-7722	72	7	62	2	413
DD711-7782	78	7	62	2	413
DD711-7842	84	7	38/38	2	483

For 84", 90", and 96" wide wall mount overheads or stacking storage units specify either a 62" wide single fixture, or DD715-7842 (US) or DD711-7842 (Chicago) for two 38" wide linked fixtures.

Specify

Product Number (tackboards)

N	F	T	-	1	2	2
---	---	---	---	---	---	---

Product Number (task lights)

D	D	7	1	-	7	2
---	---	---	---	---	---	---

Fabric

--	--	--	--	--	--	--

page 8

Notes

Wall mount tackboards are fabric wrapped and are designed to extend behind the worksurface

Task lights include cool white bulbs, and cord exit on right with a molded, grounded plug

Task lights are for use with wall mount overheads or stacking storage units

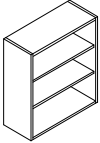
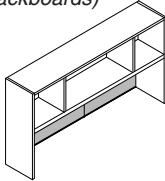
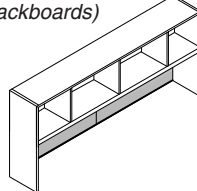
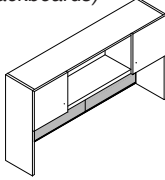
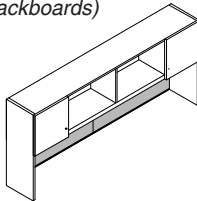
<i>For use on top of rear units and credenzas; not for use freestanding on floor</i>		Product Number	Depth	Width	Height	Basic Price
Stacking Bookcase		NOB1-153039	15	30	39	\$1,365
		NOB1-153639	15	36	39	1,519
<hr/>						
Stacking Storage • Open <i>(does not include tackboards)</i>		NU3W-156039	15	60	39	1,957
		NU3W-156639	15	66	39	2,034
		NU3W-157239	15	72	39	2,099
<hr/>						
Stacking Storage • Open <i>(does not include tackboards)</i>		NU3W-157839	15	78	39	2,201
		NU3W-158439	15	84	39	2,278
		NU3W-159039	15	90	39	2,497
		NU3W-159639	15	96	39	2,562
<hr/>						
Stacking Storage • Door / Open / Door <i>(does not include tackboards)</i>		NU7W-166039	16	60	39	2,317
		NU7W-166639	16	66	39	2,394
		NU7W-167239	16	72	39	2,459
<hr/>						
Stacking Storage • Door / Open / Door <i>(does not include tackboards)</i>		NU7W-167839	16	78	39	2,562
		NU7W-168439	16	84	39	2,640
		NU7W-169039	16	90	39	2,859
		NU7W-169639	16	96	39	2,922

Specify

Product Number

N U W - 1 6 3 9

Wood Locks

page 9 page 9

Notes

Stacking bookcase and stacking storage backs are unfinished
Stacking bookcases accommodate two rows of binders; shelves are adjustable
Task light fixtures are optional and may be specified separately; see page 107
Tackboards are required in stacking storage, specify separately

*For use on top of rear units and credenzas;
 not for use freestanding on floor*

	<i>Product Number</i>	<i>Depth</i>	<i>Width</i>	<i>Height</i>	<i>Basic Price</i>
Stacking Storage • Doors <i>(does not include tackboards)</i>	NU1W-163039	16	30	39	\$1,778
	NU1W-163639	16	36	39	1,841

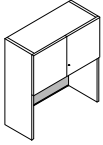

Stacking Storage • Doors <i>(does not include tackboards)</i>	NU1W-164239	16	42	39	2,150
	NU1W-164839	16	48	39	2,228
	NU1W-165439	16	54	39	2,317

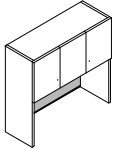

Stacking Storage • Doors <i>(does not include tackboards)</i>	NU1W-166039	16	60	39	2,523
	NU1W-166639	16	66	39	2,601
	NU1W-167239	16	72	39	2,665

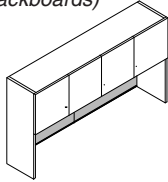

Stacking Storage • Doors <i>(does not include tackboards)</i>	NU1W-167839	16	78	39	2,910
---	--------------------	----	----	----	-------

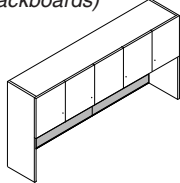

Stacking Storage • Doors <i>(does not include tackboards)</i>	NU1W-168439	16	84	39	3,128
	NU1W-169039	16	90	39	3,349
	NU1W-169639	16	96	39	3,411

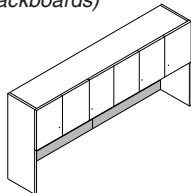

Specify

Product Number

N U 1 W - 1 6 3 9

Wood Locks

page 9

page 9

Notes

*Stacking storage backs are unfinished
 Task light fixtures are optional and may be specified separately; see page 107
 Tackboards are required in stacking storage, specify separately*

	Product Number	Stacking Storage		Width	Height	Basic Price
		Width	Depth			
Stacking Storage Tackboard • One-Piece	NFT2-12922	30	3/4	28 1/2	22	\$271
<i>concealed wire managers left and right</i>	NFT2-13522	36	3/4	34 1/2	22	283
	NFT2-14122	42	3/4	40 1/2	22	283
	NFT2-14722	48	3/4	46 1/2	22	296
	NFT2-15322	54	3/4	52 1/2	22	296

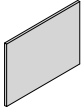

Pricing shown includes fabric in Standard price group
Additional upcharges apply for other price groups

Stacking Storage Tackboard • Two-Piece	NFT3-15922	60	3/4	58 1/2	22	490
<i>concealed wire managers left and right</i>	NFT3-16522	66	3/4	64 1/2	22	515
	NFT3-17122	72	3/4	70 1/2	22	515
	NFT3-17722	78	3/4	76 1/2	22	567
	NFT3-18322	84	3/4	82 1/2	22	567
	NFT3-18922	90	3/4	88 1/2	22	567
	NFT3-19522	96	3/4	94 1/2	22	593

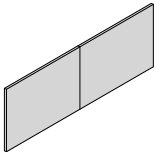

Pricing shown includes fabric in Standard price group
Additional upcharges apply for other price groups

Specify

Product Number (tackboards)

N	F	T	2	-	1			2	2
---	---	---	---	---	---	--	--	---	---

Fabric

--	--	--	--	--	--	--	--

page 8

Notes

Tackboards are required inside stacking storage units; specify tackboards which correspond to stacking storage width shown above

	Product Number	Depth	Width	Height	Basic Price
Organizer	NORA-131521	12 1/2	15	21	\$387
	NORA-131821	12 1/2	18	21	413
<p><i>Includes adjustable veneered shelves for binders, stationery or file folders (15" letter, 18" legal) Organizers are designed for use under stacking storage units</i></p> <p><i>When organizers are used under a task light, some light will be blocked from the end of the light</i></p>					
Grommet	CGK1-330		3	3	24

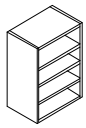

15" wide

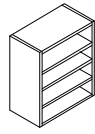

18" wide



Grommet is provided in black finish, and is designed for field installation on a 1 3/16" thick worksurface to manage wires and cables

Grommet requires a 2 1/2" diameter hole drilled for installation

Specify

Product Number (organizer)

N	O	R	A	-	1	3			2	1
---	---	---	---	---	---	---	--	--	---	---

Product Number (grommet)

C	G	K	1	-	3	3	0
---	---	---	---	---	---	---	---

Wood

--	--	--	--

page 9

Notes

Refer to the Tablet™ Casegoods pricebook for the following accessories:

- cable managers
- keyboard mechanisms
- mouse pad
- pencil drawers
- wire dividers

For use with tops and back panels or L panels to create credenzas or rear units

Low Storage • Hinged Doors

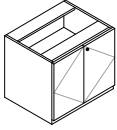

Product Number	Depth	Width	Height	Basic Price
<i>for use with back panel</i>				
TLSUC2-243028	24	30	27 1/2	\$1,416
TLSUD2-243628	24	36	27 1/2	1,480
<i>for use with no back panel</i>				
TLSUC2-253028	25	30	27 1/2	1,416
TLSUD2-253628	25	36	27 1/2	1,480

Low Storage • 2 Box / 1 File

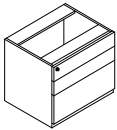

<i>for use with back panel</i>				
TLSUC4-243028	24	30	27 1/2	1,558
TLSUD4-243628	24	36	27 1/2	1,674
<i>for use with no back panel</i>				
TLSUC4-253028	25	30	27 1/2	1,558
TLSUD4-253628	25	36	27 1/2	1,674

Low Storage • 2 Files

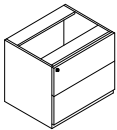

<i>for use with back panel</i>				
TLSUC5-243028	24	30	27 1/2	1,558
TLSUD5-243628	24	36	27 1/2	1,674
<i>for use with no back panel</i>				
TLSUC5-253028	25	30	27 1/2	1,558
TLSUD5-253628	25	36	27 1/2	1,674

Low Storage • 2 Files
with counterweights and anti-tilt mechanism

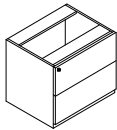

<i>for use with back panel</i>				
TLSUC5-243028-AT	24	30	27 1/2	1,781
TLSUD5-243628-AT	24	36	27 1/2	1,896
<i>for use with no back panel</i>				
TLSUC5-253028-AT	25	30	27 1/2	1,781
TLSUD5-253628-AT	25	36	27 1/2	1,896

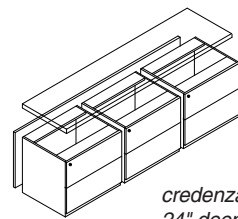

credenza with 24" deep storage

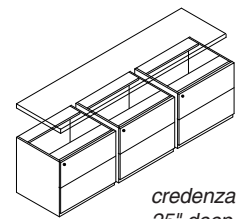

credenza with 25" deep storage

Specify

Product Number

T L S U - 2 3 2 8 -

Wood

Pull

Locks

page 9 page 9 page 9

Notes

Storage units have unfinished backs

<i>Product Number</i>	<i>Page</i>	<i>Product Number</i>	<i>Page</i>	<i>Product Number</i>	<i>Page</i>
CGK1-330	81	NSS3-18428	84	NWO2-158417	74
DD711-7302	77	NSS3-19028	84	NWO2-159017	74
DD711-7362	77	NSS3-19628	84	NWO2-159617	74
DD711-7422	77	NT07-25161	84	NWO3-164817	75
DD711-7452	77	NT07-25301	84	NWO3-165417	75
DD711-7482	77	NT07-25361	84	NWO3-166017	75
DD711-7542	77	NT07-25421	84	NWO3-166617	75
DD711-7602	77	NT07-25481	84	NWO3-167217	75
DD711-7662	77	NT07-25541	84	NWO3-167817	75
DD711-7722	77	NT07-25601	84	NWO3-168417	75
DD711-7782	77	NT07-25661	84	NWO3-169017	75
DD711-7842	77	NT07-25721	84	NWO3-169617	75
DD715-7302	77	NT07-25781	84	TBCA-143028	70
DD715-7362	77	NT07-25841	84	TBCA-143044	70
DD715-7422	77	NT07-25901	84	TBCA-143068	70
DD715-7452	77	NT07-25961	84	TBCA-143628	70
DD715-7482	77	NU1W-163039	79	TBCA-143644	70
DD715-7542	77	NU1W-163639	79	TBCA-143668	70
DD715-7602	77	NU1W-164239	79	TBEV-313629	49
DD715-7662	77	NU1W-164839	79	TBEV-314229	49
DD715-7722	77	NU1W-165439	79	TBEV-314829	49
DD715-7782	77	NU1W-166039	79	TCE4-363629	22
DD715-7842	77	NU1W-166639	79	TCE4-424229	22
NFT2-12922	80	NU1W-167239	79	TCE5-363629	22
NFT2-13522	80	NU1W-167839	79	TCE5-424229	22
NFT2-14122	80	NU1W-168439	79	TCE6-363629	22
NFT2-14722	80	NU1W-169039	79	TCE6-424229	22
NFT2-15322	80	NU1W-169639	79	TCE7-363629	22
NFT3-15922	80	NU3W-156039	78	TCE7-424229	22
NFT3-16522	80	NU3W-156639	78	TCFDC2-253029	62
NFT3-17122	80	NU3W-157239	78	TCFDC4-253029	62
NFT3-17722	80	NU3W-157839	78	TCFDC5-253029	62
NFT3-18322	80	NU3W-158439	78	TCFDD2-253629	62
NFT3-18922	80	NU3W-159039	78	TCFDD4-253629	62
NFT3-19522	80	NU3W-159639	78	TCFDD5-253629	62
NFT5-13022	77	NU7W-166039	78	TCFEC2C2-256029	63
NFT5-13622	77	NU7W-166639	78	TCFEC2C4-256029	63
NFT5-14222	77	NU7W-167239	78	TCFEC2C5-256029	64
NFT5-14522	77	NU7W-167839	78	TCFEC4C4-256029	63
NFT5-14822	77	NU7W-168439	78	TCFEC4C5-256029	63
NFT6-15422	77	NU7W-169039	78	TCFEC5C5-256029	64
NFT6-16022	77	NU7W-169639	78	TCFED2D2-257229	63
NFT6-16622	77	NWO1-163017	76	TCFED2D4-257229	63
NFT6-17222	77	NWO1-163617	76	TCFED2D5-257229	64
NFT6-17822	77	NWO1-164217	76	TCFED4D4-257229	63
NFT6-18422	77	NWO1-164817	76	TCFED4D5-257229	64
NFT6-19022	77	NWO1-165417	76	TCFED5D5-257229	63
NFT6-19622	77	NWO1-166017	76	TCFFC2C2C2-259029	65
NOB1-153039	78	NWO1-166617	76	TCFFC5C2C5-259029	65
NOB1-153639	78	NWO1-167217	76	TCFFC5C4C5-259029	65
NORA-131521	81	NWO1-167817	76	TCFFC5C5C5-259029	65
NORA-131821	81	NWO1-168417	76	TCFGA4K2A5-256629	64
NSLA-252528	84	NWO1-169017	76	TCFGA4L2A5-257229	64
NSS3-11628	84	NWO1-169617	76	TCFGA5K2A5-256629	64
NSS3-13028	84	NWO2-153017	74	TCFGA5L2A5-257229	64
NSS3-13628	84	NWO2-153617	74	TCRDC2-253029	62
NSS3-14228	84	NWO2-154217	74	TCRDC4-253029	62
NSS3-14828	84	NWO2-154817	74	TCRDC5-253029	62
NSS3-15428	84	NWO2-155417	74	TCRDD2-253629	62
NSS3-16028	84	NWO2-156017	74	TCRDD4-253629	62
NSS3-16628	84	NWO2-156617	74	TCRDD5-253629	62
NSS3-17228	84	NWO2-157217	74	TCREC2C2-256029	63
NSS3-17828	84	NWO2-157817	74	TCREC2C4-256029	63

<i>Product Number</i>	<i>Page</i>	<i>Product Number</i>	<i>Page</i>	<i>Product Number</i>	<i>Page</i>
TCREC2C5-256029	64	TDF5LA4-376629	11	TDS5LA4-376029	10
TCREC4C4-256029	63	TDF5LA4-377229	11	TDS5LA4-376629	10
TCREC4C5-256029	64	TDF5LA4-377829	11	TDS5LA4-377229	10
TCREC5C5-256029	63	TDF5RA4-376029	11	TDS5LA4-377829	10
TCRED2D2-257229	63	TDF5RA4-376629	11	TDS5RA4-376029	10
TCRED2D4-257229	63	TDF5RA4-377229	11	TDS5RA4-376629	10
TCRED2D5-257229	64	TDF5RA4-377829	11	TDS5RA4-377229	10
TCRED4D4-257229	63	TDF6A4A4-376029	15	TDS5RA4-377829	10
TCRED4D5-257229	64	TDF6A4A4-376629	15	TDS6A4A4-376029	15
TCRED5D5-257229	63	TDF6A4A4-377229	15	TDS6A4A4-376629	15
TCRFC2C2C2-259029	65	TDF6A4A4-377829	15	TDS6A4A4-377229	15
TCRFC5C2C5-259029	65	TDF6A4A5-376029	14	TDS6A4A4-377829	15
TCRFC5C4C5-259029	65	TDF6A4A5-376629	14	TDS6A4A5-376029	14
TCRFC5C5C5-259029	65	TDF6A4A5-377229	14	TDS6A4A5-376629	14
TCRGA4K2A5-256629	64	TDF6A4A5-377829	14	TDS6A4A5-377229	14
TCRGA4L2A5-257229	64	TDF7LA4-436629	13	TDS6A4A5-377829	14
TCRGA5K2A5-256629	64	TDF7LA4-437229	13	TDS7LA4-436629	12
TCRGA5L2A5-257229	64	TDF7LA4-437829	13	TDS7LA4-437229	12
TCU4-363629	23	TDF7RA4-436629	13	TDS7LA4-437829	12
TCU4-424229	23	TDF7RA4-437229	13	TDS7RA4-436629	12
TCU5-363629	23	TDF7RA4-437829	13	TDS7RA4-437229	12
TCU5-424229	23	TDF8A4A4-436629	17	TDS7RA4-437829	12
TDEJL-317229	20	TDF8A4A4-437229	17	TDS8A4A4-436629	16
TDEJL-317829	20	TDF8A4A4-437829	17	TDS8A4A4-437229	16
TDEJL-318429	20	TDF8A4A5-436629	17	TDS8A4A4-437829	16
TDEJR-317229	20	TDF8A4A5-437229	17	TDS8A4A5-436629	16
TDEJR-317829	20	TDF8A4A5-437829	17	TDS8A4A5-437229	16
TDEJR-318429	20	TDF9LA4-316029	11	TDS8A4A5-437829	16
TDEKL-317229	20	TDF9LA4-316629	11	TDS9LA4-316029	10
TDEKL-317829	20	TDF9LA4-317229	11	TDS9LA4-316629	10
TDEKL-318429	20	TDF9LA4-317829	11	TDS9LA4-317229	10
TDEKR-317229	20	TDF9RA4-316029	11	TDS9LA4-317829	10
TDEKR-317829	20	TDF9RA4-316629	11	TDS9RA4-316029	10
TDEKR-318429	20	TDF9RA4-317229	11	TDS9RA4-316629	10
TDEML-316029	18	TDF9RA4-317829	11	TDS9RA4-317229	10
TDEML-316629	18	TDFAA4A4-316029	15	TDS9RA4-317829	10
TDEML-317229	18	TDFAA4A4-316629	15	TDSAA4A4-316029	15
TDEMR-316029	18	TDFAA4A4-317229	15	TDSAA4A4-316629	15
TDEMR-316629	18	TDFAA4A4-317829	15	TDSAA4A4-317229	15
TDEMR-317229	18	TDFAA4A4-376029	15	TDSAA4A4-317829	15
TDENL-376629	18	TDFAA4A4-376629	15	TDSAA4A4-376029	15
TDENL-377229	18	TDFAA4A4-377229	15	TDSAA4A4-376629	15
TDENL-377829	18	TDFAA4A4-377829	15	TDSAA4A4-377229	15
TDENL-378429	18	TDFAA4A5-316029	14	TDSAA4A4-377829	15
TDENR-376629	18	TDFAA4A5-316629	14	TDSAA4A5-316029	14
TDENR-377229	18	TDFAA4A5-317229	14	TDSAA4A5-316629	14
TDENR-377829	18	TDFAA4A5-317829	14	TDSAA4A5-317229	14
TDENR-378429	18	TDFAA4A5-376029	14	TDSAA4A5-317829	14
TDEPL-316029	19	TDFAA4A5-376629	14	TDSAA4A5-376029	14
TDEPL-316629	19	TDFAA4A5-377229	14	TDSAA4A5-376629	14
TDEPL-317229	19	TDFAA4A5-377829	14	TDSAA4A5-377229	14
TDEPR-316029	19	TDFDLA4-376029	13	TDSAA4A5-377829	14
TDEPR-316629	19	TDFDLA4-376629	13	TSDLA4-376029	12
TDEPR-317229	19	TDFDLA4-377229	13	TSDLA4-376629	12
TDEQL-376629	19	TDFDRA4-376029	13	TSDLA4-377229	12
TDEQL-377229	19	TDFDRA4-376629	13	TSDRA4-376029	12
TDEQL-377829	19	TDFDRA4-377229	13	TSDRA4-376629	12
TDEQL-378429	19	TDFEA4A4-376029	17	TSDRA4-377229	12
TDEQR-376629	19	TDFEA4A4-376629	17	TDSEA4A4-376029	16
TDEQR-377229	19	TDFEA4A4-377229	17	TDSEA4A4-376629	16
TDEQR-377829	19	TDFEA4A5-376029	17	TDSEA4A4-377229	16
TDEQR-378429	19	TDFEA4A5-376629	17	TDSEA4A5-376029	16
TDF5LA4-376029	11	TDFEA4A5-377229	17	TDSEA4A5-376629	16

<i>Product Number</i>	<i>Page</i>	<i>Product Number</i>	<i>Page</i>	<i>Product Number</i>	<i>Page</i>
TLO2LC5C5-258429	34	TLSUD4-243628	83	TREALA5-256029	53
TLO2LC5C5-259029	34	TLSUD4-253628	83	TREALA5-256629	53
TLO2LC5C5-259629	34	TLSUD5-243628	83	TREALA5-257229	53
TLO2RA4C5-256029	32	TLSUD5-243628-AT	83	TREALA5-257829	53
TLO2RA4C5-256629	32	TLSUD5-253628	83	TREALC5-256629	55
TLO2RA4C5-257229	32	TLSUD5-253628-AT	83	TREALC5-257229	55
TLO2RA4C5-257829	32	TMTE-253029	70	TREALC5-257829	55
TLO2RA4C5-258429	32	TMTE-253629	70	TREALC5-258429	55
TLO2RC5C5-257829	34	TPDUA4-241628	82	TREARA4-256029	51
TLO2RC5C5-258429	34	TPDUA4-251628	82	TREARA4-256629	51
TLO2RC5C5-259029	34	TPDUA5-241628	82	TREARA4-257229	51
TLO2RC5C5-259629	34	TPDUA5-241628-AT	82	TREARA4-257829	51
TLOALA4-253629	38	TPDUA5-251628	82	TREARA5-256029	53
TLOALA4-254229	38	TPDUA5-251628-AT	82	TREARA5-256629	53
TLOALA4-254829	38	TPM2A7-191626	82	TREARA5-257229	53
TLOALA5-253629	40	TPM2A7-241626	82	TREARA5-257829	53
TLOALA5-254229	40	TRCALA4-256029	50	TREARC5-256629	55
TLOALA5-254829	40	TRCALA4-256629	50	TREARC5-257229	55
TLOALC5-254829	42	TRCALA4-257229	50	TREARC5-257829	55
TLOALC5-255429	42	TRCALA4-257829	50	TREARC5-258429	55
TLOALC5-256029	42	TRCALA5-256029	52	TREBLC5A4-257829	57
TLOARA4-253629	38	TRCALA5-256629	52	TREBLC5A4-258429	57
TLOARA4-254229	38	TRCALA5-257229	52	TREBLC5A4-259029	57
TLOARA4-254829	38	TRCALA5-257829	52	TREBLC5A4-259629	57
TLOARA5-253629	40	TRCALC5-256629	54	TREBLC5A5-257829	59
TLOARA5-254229	40	TRCALC5-257229	54	TREBLC5A5-258429	59
TLOARA5-254829	40	TRCALC5-257829	54	TREBLC5A5-259029	59
TLOARC5-254829	42	TRCALC5-258429	54	TREBLC5A5-259629	59
TLOARC5-255429	42	TRCARA4-256029	50	TREBLC5C5-259029	61
TLOARC5-256029	42	TRCARA4-256629	50	TREBLC5C5-259629	61
TLOBLC5A4-256629	44	TRCARA4-257229	50	TREBRA4C5-257829	57
TLOBLC5A4-257229	44	TRCARA4-257829	50	TREBRA4C5-258429	57
TLOBLC5A4-257829	44	TRCARA5-256029	52	TREBRA4C5-259029	57
TLOBLC5C5-257829	46	TRCARA5-256629	52	TREBRA4C5-259629	57
TLOBLC5C5-258429	46	TRCARA5-257229	52	TREBRA5C5-257829	59
TLOBRA4C5-256629	44	TRCARA5-257829	52	TREBRA5C5-258429	59
TLOBRA4C5-257229	44	TRCARC5-256629	54	TREBRA5C5-259029	59
TLOBRA4C5-257829	44	TRCARC5-257229	54	TREBRA5C5-259629	59
TLOBRC5C5-257829	46	TRCARC5-257829	54	TREBRC5C5-259029	61
TLOBRC5C5-258429	46	TRCARC5-258429	54	TREBRC5C5-259629	61
TLOSL-253029	24	TRCBLC5A4-257829	56	TROALA4-256029	50
TLOSL-253629	24	TRCBLC5A4-258429	56	TROALA4-256629	50
TLOSL-254229	24	TRCBLC5A4-259029	56	TROALA4-257229	50
TLOSR-253029	24	TRCBLC5A4-259629	56	TROALA4-257829	50
TLOSR-253629	24	TRCBLC5A5-257829	58	TROALA5-256029	52
TLOSR-254229	24	TRCBLC5A5-258429	58	TROALA5-256629	52
TLOTL-253629	36	TRCBLC5A5-259029	58	TROALA5-257229	52
TLOTL-254229	36	TRCBLC5A5-259629	58	TROALA5-257829	52
TLOTL-254829	36	TRCBLC5C5-259029	60	TROALC5-256629	54
TLOTR-253629	36	TRCBLC5C5-259629	60	TROALC5-257229	54
TLOTR-254229	36	TRCBRA4C5-257829	56	TROALC5-257829	54
TLOTR-254829	36	TRCBRA4C5-258429	56	TROALC5-258429	54
TLRBL-485429	21	TRCBRA4C5-259029	56	TROARA4-256029	50
TLRBR-485429	21	TRCBRA4C5-259629	56	TROARA4-256629	50
TLSUC2-243028	83	TRCBRA5C5-257829	58	TROARA4-257229	50
TLSUC2-253028	83	TRCBRA5C5-258429	58	TROARA4-257829	50
TLSUC4-243028	83	TRCBRA5C5-259029	58	TROARA5-256029	52
TLSUC4-253028	83	TRCBRA5C5-259629	58	TROARA5-256629	52
TLSUC5-243028	83	TRCBRC5C5-259029	60	TROARA5-257229	52
TLSUC5-243028-AT	83	TRCBRC5C5-259629	60	TROARA5-257829	52
TLSUC5-253028	83	TREALA4-256029	51	TROARC5-256629	54
TLSUC5-253028-AT	83	TREALA4-256629	51	TROARC5-257229	54
TLSUD2-243628	83	TREALA4-257229	51	TROARC5-257829	54
TLSUD2-253628	83	TREALA4-257829	51	TROARC5-258429	54

<i>Product Number</i>	<i>Page</i>	<i>Product Number</i>	<i>Page</i>	<i>Product Number</i>	<i>Page</i>
TROBLC5A4-257829	56				
TROBLC5A4-258429	56				
TROBLC5A4-259029	56				
TROBLC5A4-259629	56				
TROBLC5A5-257829	58				
TROBLC5A5-258429	58				
TROBLC5A5-259029	58				
TROBLC5A5-259629	58				
TROBLC5C5-259029	60				
TROBLC5C5-259629	60				
TROBRA4C5-257829	56				
TROBRA4C5-258429	56				
TROBRA4C5-259029	56				
TROBRA4C5-259629	56				
TROBRA5C5-257829	58				
TROBRA5C5-258429	58				
TROBRA5C5-259029	58				
TROBRA5C5-259629	58				
TROBRC5C5-259029	60				
TROBRC5C5-259629	60				
TUCU-252429	48				
TUCU-253029	48				
TUCU-253629	48				
TUCU-254229	48				
TUCU-254829	48				
TUCV-253629	49				
TUCV-254229	49				
TUCV-254829	49				
TUCV-313629	49				
TUCV-314229	49				
TUCV-314829	49				
TUEU-252429	48				
TUEU-253029	48				
TUEU-253629	48				
TUEU-254229	48				
TUEU-254829	48				
TUOU-25241	48				
TUOU-25301	48				
TUOU-25361	48				
TUOU-25421	48				
TUOV-25361	49				
TUOV-25421	49				
TUOV-31361	49				
TUOV-31421	49				
TVS3-253068	73				
TVS3-253668	73				
TVS4-253068	73				
TVS4-253668	73				
TVS6-253068	73				
TVS6-253668	73				
TVS7-253068	73				
TVS7-253668	73				
TVSK-251668	72				
TVSL-251668	72				
TVSM-251668	72				
TVSN-251668	72				
TVSP-251668	71				
TVSQ-251668	71				
TVSR-251668	71				
TVSS-251668	71				

Index

Keyeira™ Casegoods were designed by Geiger Design Group.

© 2011 Geiger International, Inc. All rights reserved.

® Geiger International is a registered trademark of Geiger International, Inc.

® Herman Miller is among the registered trademarks of Herman Miller, Inc., and its owned subsidiaries.

™ The Geiger logo, Keyeira, Bristol, Callalo, Caribana, Classic Lines, Con Brio, Fragments, Honeycore, Letter Box, Modern Cord, Modern Times and Streamers are trademarks of Geiger International, Inc., and/or of its independent designers.

™ Bailey and Groove are trademarks of True Textiles, Inc. (formerly Interface Fabrics Group).

Bergamo and Luna Textiles are property of their respective companies. All rights reserved.

Serial #11PBKEY-09