



## MP™ Tables

Prices effective July 5, 2023

Published July 5, 2023

### Specification Information

General Information.....	2
How to Specify.....	4
Base Finishes.....	5
Casters.....	5
Edge Details.....	6
Glass.....	7
Grommet Finishes.....	7
Laminate Finishes.....	8
Metal Finishes.....	8
Paint Finishes.....	9
Power Modules.....	9
Stone/Marble.....	10
Wood Finishes.....	11
Seating Capacity.....	13
MP Flex Table Product Features.....	14-17
MP Flex Table Sample Configurations.....	18-20
MP Height Adjustable Table Product Features.....	21
MP Tables.....	22-61
MP Flex Tables.....	62-91
MP Height Adjustable Tables.....	92-97
Index.....	98

# General Information

## Terms and Conditions

## Order Information

# GEIGER

### Application of Standard Terms

Only the standard terms of sale stated in this catalog apply to any transaction unless those terms are modified or supplemented by a written document signed by an officer of Geiger International, Inc. ("Geiger"). Any terms contained in Customer's purchase order, including standard printed provisions, that are additional to or contrary to these terms, are not effective.

### Use of Furniture and Materials

Geiger assumes that textiles, leathers and products are intended for commercial use and are not being bought for use primarily for personal, family, or household purposes. When installed and used as intended, products remain chattel property, are not considered fixtures, and no interest in them should arise under applicable real estate law.

### Furniture Prices

Prices are determined by using the published list prices in effect when Geiger receives Customer's completed purchase order. If Customer's requested ship date is more than three months after Geiger receives Customer's order, it may be repriced using the list prices in effect when products ship. If Customer designates special finishes or options, additional charges may apply. Services such as design, project management, packaging, storage, inside delivery, double handling, installation, or inventory management are not included in Geiger's list prices.

### COM / COL Procedures

If an order includes Customer-supplied materials, Customer must ship those materials to Geiger at Customer's own expense. The materials must be tagged with Geiger's confirmation number, item number, Customer's name, and purchase order number. Geiger is not liable for inadequacies in Customer's materials. Geiger will notify Customer of any apparent defects in Customer's materials before manufacturing.

### Taxes

Customer is responsible for any local sales taxes or other similar taxes imposed on transactions.

### Delays

Geiger is not liable for failure to ship by the acknowledged shipping date or any other date. Geiger is not liable for a delay or failure in shipment or performance if the delay or failure is caused by acts of omission of Customer, its agents, employees, contractors, a governmental authority, or God; delays in transportation; or other similar causes that are not within Geiger's reasonable control. Geiger is excused from further performance of its obligations for the duration of a force majeure cause.

### Changes and Cancellation

Geiger's acceptance of an order is final and binding and an order may not be changed or canceled without Geiger's written consent.

Orders placed on any of Geiger's expedited shipment programs and orders of custom-dyed or custom-woven materials may not be changed or canceled. To change or cancel other orders, contact Geiger Customer Care in writing for authorization and applicable charges.

### Storage

If Customer cannot accept delivery when products are ready, it is the customer's responsibility to transfer products to storage and products are invoiced at that time. Customer is responsible for actual storage charges and any other expenses relating to the storage of products or materials. Customer bears all risk of loss for products or materials in storage.

### Freight Terms

For casegoods and seating orders shipped within the 48 contiguous United States, surface freight charges are included. For textile and leather orders actual freight charges will be invoiced. Orders are shipped via ground carrier unless requested otherwise.

For orders shipped to Alaska or Hawaii, the freight terms stated above apply only to the port of embarkation. Shipments beyond that point are freight collect. Domestic deliveries are shipped FOB Geiger's plant to a destination designated by Customer by a method Geiger selects.

All textile shipments will be made FOB Geiger Textiles, Yaphank, NY 11980. All leather shipments will be made FOB Geiger Textiles, Hildebrand, NC 28637.

### Packaging and Shipping

Geiger's casegoods products are shipped in component form. Shipments over \$50,000 net are blanket wrapped. Tops and panels are shrink wrapped with cardboard corner protection. Pedestals, storage units, overheads and vertical storage units are wrapped in blankets and shrink wrapped with cardboard corner protection. Blankets are to be returned to Geiger for reuse. If the customer request cartoning on orders over \$50,000 net, there will be a charge of five percent of the net order. Packing materials are recyclable.

Casegood shipments from Atlanta under \$50,000 net are cartoned. Cartoned shipments are packaged with cardboard channels and shrink wrap.

Geiger's seating is cartoned in boxes for all shipments. Blanket wrapping is available upon request.

If Customer requests special shipping or delivery methods, Customer is responsible for any extra costs that result.

### Packaging and Shipping (continued)

Customer obtains title to products and materials and assumes the risk of loss for them upon shipment from Geiger's plant. Geiger reserves the right to make partial shipments, of truckload quantities, as products are manufactured.

### Shipping Surcharge

A shipping surcharge will be added to all orders under \$100,000 list based on the ship-to address. The surcharge is a percentage of the total list price of the entire order, calculated on the base price only. Upcharges for veneer, edges, textiles, pulls, etc., are not counted in the calculation.

Zone 1	3.6% (GA, NC, SC)
Zone 2	4.2% (AL, FL, MS, TN, AR, LA)
Zone 3	4.8% (IL, IN, KY, MI, OH, WI, IA, KS, MN, MO, ND, NE, SD, DC, MD, VA)
Zone 4	5.4% (CT, MA, ME, NH, RI, VT, DE, NJ, NY, PA, WV)
Zone 5	6.0% (OK, TX, AZ, NM, NV, UT, CO)
Zone 6	6.6% (OR, WA, ID, MT WY, CA, Canada)

### International Shipping

Orders for export are shipped Ex Works factory (Incoterms 2000). The charge for export packing is five percent of the net order value. There are no export packing charges on shipments to Canada.

### Claims

All blanket wrapped shipments must be unwrapped and inspected at the dock, in the presence of the driver. Claims for "concealed damage" or "subject to inspection" will not be honored on blanket wrapped shipments. All cartoned shipments must be inspected for visual outside damage to the package.

Damages and piece count shortages must be noted on the bill of lading. Freight claims must be filed within 30 days (including cartoned shipments with concealed damage). Contact Customer Care for a warranty/freight claim form and send it by fax, mail or email to:

Geiger International  
6095 Fulton Industrial Blvd., SW  
Atlanta, GA 30336-2806  
Attention: Warranty Department  
Fax: 1.404.836.7519

### Order Information

Herman Miller dealers must submit all purchase orders to Geiger via Omni. For assistance with this process, please contact Herman Miller Sales Technology Support at 800.833.3330.

All Geiger Gallery and non-Herman Miller dealers may submit their orders via email or fax at 404.836.7519. For assistance with this

### Order Information (continued)

process, please contact Geiger Customer Care at 800.456.6452.

Midwest	custcaremw@geigerfurniture.com
New York	custcareny@geigerfurniture.com
Northeast	custcarene@geigerfurniture.com
South	custcaresouth@geigerfurniture.com
West	custcarewest@geigerfurniture.com
Int'l	custcareintl@geigerfurniture.com

### Warranty

Geiger International, Inc. ("Geiger"), 6095 Fulton Industrial Blvd., SW, Atlanta, GA 30336-2806, USA, warrants the products sold by it to be free from defects in material and workmanship, regardless of the number of shifts during which the products are used, for the warranty periods specified below.

This warranty covers the sale of Geiger product in all countries. Not all of the product lines appearing on this list are marketed by Geiger in all countries, and appearance on this list does not imply an offer for sale of a product line in a particular place. Product line availability is defined in current price lists applicable to different regions.

#### Geiger Commercial Office Furniture Products 12 years

All products sold under the Geiger® brand name, except as limited or described below.

#### Textiles and Leathers 3 years

Includes, but is not limited to Edelman Leather, Geiger, Herman Miller, Maharam, and Place fabrics.

#### Nonstandard Products 1 to 5 years

Warranty length on nonstandard products not covered by the 12-year warranty is identified on individual product quotes.

#### All Other Products, Parts, and Services 2 years

Height adjustable bases (electrical parts)

#### 5 years

Height adjustable bases (mechanical parts)  
Task light electronic ballasts

#### 3 years

All service parts

#### 6 months

All other products, parts, and any services not listed above, sold or furnished by Geiger, except for consumable products such as light bulbs and other electronic products for which no warranty is given

#### Other Manufacturers' Products

#### None

Geiger will pass through to the original purchaser any warranty supplied by other manufacturers to the extent possible, including, but not limited to, open-line laminates.

### Warranty (continued)

#### Provisions that apply to all products and services:

During the applicable warranty period, Geiger, as its sole obligation, will repair or replace (at its option) any product, part, or component covered by this warranty and sold after the effective date of this warranty, which fails under normal use as a result of a defect in material or workmanship; Geiger will repair or replace the aforementioned product, part, or component with a comparable product, part, or component.

This warranty extends only to the original purchasers who acquire new product from Geiger, or its authorized resellers. Any product, part, or component must have been installed, used, and maintained according to Geiger's published instructions in order to be eligible for coverage under this warranty and must not have been subject to misuse or abuse. Any modification to the original product voids the warranty. Geiger does not warrant the performance of the product when used in combination with other than original Geiger product.

The warranty period starts from the date of purchase.

This document inclusively describes all of the warranties given and remedies available with respect to the company's products and services. Geiger disclaims any other warranty whether express or implied, statutory or otherwise, in relation to the products.

Geiger does not warrant:

- natural variations in wood grain or figure or the presence of character marks
- changes in surface finishes due to aging or exposure to light
- marks, scars, or wrinkles occurring naturally in leather
- veins, marks, voids, fissures, or cracks found naturally in stone

In addition, Geiger does not warrant:

- failure resulting from normal wear and tear
- the matching of colors, grains, or textures of natural materials
- the colorfastness or the matching of colors of textiles, including an exact match to cuttings or to swatch cards
- damage, marking, or staining of veneer surfaces due to contact with rubber or similar compounds; damage from sharp objects or imprinting from writing instruments, or prolonged exposure to direct sunlight

Geiger tests Customer's Own Material (COM) and other customer-supplied items for manufacturing quality only and does not provide any warranty with regard to these materials.

Geiger does not warrant products that are exposed to extreme environmental conditions or that have been subject to improper storage.

### Warranty (continued)

Geiger's products meet the requirements of national and specific local codes as stated in the price books and other written publications.

**TO THE EXTENT ALLOWED BY LAW, ANY IMPLIED WARRANTIES, INCLUDING ANY WARRANTY OF MERCHANTABILITY OR FITNESS FOR A PARTICULAR PURPOSE, ARE DISCLAIMED AND TO THE EXTENT THEY ARE LEGALLY REQUIRED, ARE LIMITED IN DURATION TO THE DURATION OF THIS WRITTEN WARRANTY.**

**GEIGER SHALL NOT BE LIABLE FOR LOSS OF TIME, INCONVENIENCE, COMMERCIAL LOSS, OR INCIDENTAL OR CONSEQUENTIAL DAMAGES.**

Applies in US only: Some states do not allow limitations on how long an implied warranty lasts or do not allow the exclusion or limitation of incidental or consequential damages, so the limitations or exclusions in the two preceding paragraphs may not apply. This warranty gives the purchaser specific legal rights; however, the purchaser may also have other rights that may vary from state to state.

Applies outside US: Except as stated above, Geiger will not be liable for any loss or damage (including costs) however caused, whether direct or consequential, incurred or suffered by the purchaser or any third party in respect of the products but nothing contained herein will or will be considered to exclude or restrict any liability on Geiger's part for death or personal injury resulting from negligence.

### Limitations and Disclaimers

Geiger is not liable for loss of time, inconvenience, lost profits, commercial loss, or other special, consequential, or incidental damages for any transaction.

Geiger reserves the right to change its designs, its methods of construction, or its prices, charges, or policies at any time without notice to Customer.

### Design Rights

The designs depicted in Geiger's catalogs and price lists are proprietary to Geiger and Geiger reserves the exclusive right to manufacture them. Any reproduction of these designs infringes Geiger's rights and that infringement will be prosecuted.

### *How to Specify*

- For each product ordered, specify a product number string. The string should include the product number and all finish and detail codes listed at the bottom of the pricebook page.
- Specify the finishes and details in the same sequence shown on the pricebook page.
- Product Number String Example:  
AM1WF-24 943 WE3 CHR  
The product number string above includes all required codes for a MP round table with the following specifications:  
  
Product Number ..... AM1WF-24  
Wood Finish..... 943 Caramel Cherry  
Edge Detail..... WE3 Eased  
Leg Finish..... CHR Chrome
- Basic Price reflects the price of the table without optional features. Add upcharges as shown on the product page for anigre wood finishes, solid edge detail, or base finish.

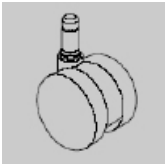
Base Finishes	Casters	
<p><b>Base Finishes</b> For all MP table bases (no upcharge)</p> <p>926.....Black AS.....Arctic Silver EH.....Metallic Bronze MS.....Metallic Silver PBZ.....Powder Coat Bronze WHT.....White</p>	<p><b>Casters</b> For MP Flex tables (no upcharge)</p> <p>HD.....Hard dual wheels, black ST.....Soft dual wheels, black</p>	
<p><b>Upcharge Base Metal Finishes</b> For all MP table bases (add upcharge shown on product page)</p>	<p><b>Notes</b></p>	
<p>CHR.....Chrome SAC.....Satin Chrome</p>	<p>All casters are 2" diameter and can be used with carpet.</p> <p>MP Flex table casters are locking.</p>	

### Edge Details

#### Basic Edge Detail

*For 1 1/8" thick laminate MP Flex table tops  
(no upcharge)*

ECE .....Laminate with PVC Eased

#### Basic Edge Detail

*For 1 1/4" thick wood standard and height  
adjustable MP table tops  
(no upcharge)*

WL3 .... Incline

WE3 .... Eased

#### Basic Edge Detail

*For 1 1/4" thick wood MP Flex table tops  
(no upcharge)*

WE3 ... Eased

#### Notes

ECE edge is 1-1/8" thick  
WL3 edge is 1-1/4" thick  
WE3 edge is 1-1/4" thick

Glass	Grommet Finishes	
-------	------------------	--

Glass
<i>For MP tables with clear glass top</i>

GIC ..... Clear Glass

Glass
<i>For MP tables with back-painted glass top</i>

GBP ..... Cloud Nine  
G52 ..... Silver Lining

Grommet
<i>For MP tables with one small grommet</i>

SAS ..... Arctic Silver  
S926 ..... Black  
SBNZ ..... Bronze  
SCHR ..... Chrome  
SEH ..... Metallic Bronze (powder-coat)  
SMS ..... Metallic Silver (powder-coat)  
SSAC ..... Satin Chrome  
SWHT ..... White

Grommet
<i>For MP tables with two small grommets</i>

2SAS ..... Arctic Silver  
2S926 ..... Black  
2SBNZ ..... Bronze  
2SCHR ..... Chrome  
2SEH ..... Metallic Bronze (powder-coat)  
2SMS ..... Metallic Silver (powder-coat)  
2SSAC ..... Satin Chrome  
2SWHT ..... White

Notes
-------

Small grommet is metal and provides a 1 1/2" diameter opening (without removable cover plate).



CGS1  
small grommet

# MP Tables

Laminates • Metal

# GEIGER

<b>Laminate Finishes</b>	<b>Metal Finishes</b>	
<p><b>Laminate</b> For MP Flex tables with laminate tops</p> <p>I54.....Folkstone Grey (HMI code 8Q)            I60.....Soft White (HMI code LU)            I65.....Chalk White (HMI code X1)            I73.....Black Umber (HMI code BU)            I74.....Inner Tone Light (HMI code HF)            I75.....Light Tone (HMI code LT)            I76.....Medium Tone (HMI code MT)            I77.....Cool Grey Neutral (HMI code CL)            I78.....Inner Tone (HMI code HT)            I81.....Warm Grey Neutral (HMI code WN)            I84.....White (HMI code 91)            I92.....Studio White (HMI code 98)</p>	<p><b>Metal Finishes</b> For MP Flex tables with one large grommet</p> <p>AS.....Arctic Silver            CHR.....Chrome            SAC.....Satin Chrome</p>	<p><b>Metal Finishes</b> For height adjustable MP table desktop power units for field installation</p> <p>926.....Black            AS.....Arctic Silver            DN.....Dark Nickel            SAC.....Satin Chrome            WHT.....White</p>
<p><b>Notes</b></p> <p>When ordering samples please use HMI codes.</p>	<p><b>Notes</b></p> <p>Rectangular grommet is metal and provides a 3 1/2" x 11 5/8" rectangular opening with a flip-up lid.</p> <div data-bbox="544 682 771 819" data-label="Image"> </div> <p style="text-align: center;"><i>MP Flex rectangular grommet</i></p>	



**Paint Finishes**

**Paint Finishes**

*For MP tables with back-painted glass top*

- 151.....Cloud Nine
- 152.....Silver Lining

**Paint Finishes**

*For MP tables with stone top*

- 151.....Cloud Nine
- 152.....Silver Lining
- 154.....In the Black

**Paint Finishes**

*For MP height adjustable modesty panels*

- CKW.....Chalk White (matches HMI X1)
- LU.....Soft White
- 8Q.....Folkstone Gray
- 91.....White
- 151.....Cloud 9
- 152.....Silver Lining
- 153.....Pipe Dream
- 154.....In the Black
- 161.....Feather
- 162.....Saddle Up
- 163.....Coffee Talk
- 169.....Fired Up
- 171.....Swimmingly
- 172.....Sky High
- 173.....Midnight Oil
- 179.....Treatment
- 181.....Sage Advice
- 182.....Money Talks
- 183.....Ivy League
- 189.....Limelight
- 191.....The Crop
- 192.....Go for the Gold
- 193.....Bronze Age
- 199.....Spice of Life

**Power Module / Plug Strip**

**Power Module**

*For MP Flex tables with power, 72" cord with 3-prong plug (no upcharge)*

- PMPLG ..... 2 power/2 data
- PMSPL ..... 2 power/1 data/1 USB

**Power Module**

*For MP Flex tables with power, modular connector, by-pass cable (add +\$99 upcharge)*

- PNMBP ..... 2 power/2 data
- PNSBP ..... 2 power/1 data/1 USB

**Power Module**

*For MP Flex tables with power, modular connector, by-pass cable, power starter kit (add +\$411 upcharge)*

- PNMSK ..... 2 power/2 data
- PNSSK ..... 2 power/1 data/1 USB

**Plug Strip**

*For MP height adjustable tables*

- MPH..... Hardwired (add \$63)
- MPP..... Plug-in

# MP Tables

Stone / Marble

GEIGER

## Stone / Marble

### Stone/Marble Options

*For MP tables with stone/marble tops*

200.....Perlato Marble  
250.....Verde Antique Marble  
400.....Black Granite  
5U.....Georgia Grey Marble  
800.....Autumn Brown Granite  
960.....White Carrara Marble  
DP.....Georgia White Marble

Wood Finishes				Upcharges	
Code	Description	Sheen	Solid	Excluding Hgt Adj Tables	Height Adjustable Tables
662	Toasted Walnut, Flat Cut, Book-Matched	Matte	Walnut		
663	Charred Walnut, Flat Cut, Book-Matched	Matte	Walnut		
664	Bronzed Walnut, Flat Cut, Book-Matched	Matte	Walnut		
665	Smoked Walnut, Flat Cut, Book-Matched	Matte	Walnut		
666	Coffee Walnut, Flat Cut, Book-Matched	Matte	Walnut		
667	Smoked Paldao, Quarter Cut, Slip-Matched	Matte	Walnut	+15%	+5%
668	Figured Sycamore, Quarter Cut, Slip-Matched	Matte	Maple	+40%	+13%
669	Warm Paldao, Quarter Cut, Slip-Matched	Matte	Walnut	+15%	+5%
677	Chocolate Ash, Flat Cut, Book-Matched	Matte	Ash		
678	Natural Oak, flat cut, book-matched	matte	Oak		
68R	Recograin Rosewood, Flat Cut, Slip-Matched *	Matte	N/A		
68W	Recograin Walnut, Flat Cut, Slip-Matched *	Matte	N/A	-5%	-2%
69A	Recograin Frosty Ash, Quarter Cut, Slip-Matched *	Matte	N/A		
69K	Recograin Oak, Quarter Cut, Slip-Matched *	Matte	N/A	-5%	-2%
69R	Recograin Rosewood, Quarter Cut, Slip-Matched *	Matte	N/A		
69T	Recograin Teak, Quarter Cut, Slip-Matched *	Matte	N/A		
69W	Recograin Walnut, Quarter Cut, Slip-Matched *	Matte	N/A	-5%	-2%
6A1	White Ash, Quarter Cut, Slip-Matched	Matte	Ash		
6K1	Rift Oak, Rift Cut, Slip-Matched	Matte	Oak		
6K6	Burnt Oak, Rift Cut, Slip-Matched	Matte	Oak		
911	Champagne Maple, Flat Cut, Book-Matched	Low	Maple		
941	Champagne Beech, Flat Cut, Book-Matched	Low	Beech		
942	Sundance Cherry, Flat Cut, Book-Matched	Low	Cherry		
943	Caramel Cherry, Flat Cut, Book-Matched	Low	Cherry		
946	Cocoa Cherry, Flat Cut, Book-Matched	Low	Cherry		
951	Champagne Anigre, Quarter Cut, Slip-Matched *	Low	N/A	+40%	+13%
956	Cocoa Sapele, Quarter Cut, Slip-Matched	Low	Mahogany		
962	Toasted Walnut, Flat Cut, Book-Matched	Low	Walnut		
963	Charred Walnut, Flat Cut, Book-Matched	Low	Walnut		
964	Bronzed Walnut, Flat Cut, Book-Matched	Low	Walnut		
965	Smoked Walnut, Flat Cut, Book-Matched	Low	Walnut		
966	Coffee Walnut, Flat Cut, Book-Matched	Low	Walnut		
967	Smoked Paldao, Quarter Cut, Slip-Matched	Low	Walnut	+15%	+5%
968	Figured Sycamore, Quarter Cut, Slip-Matched	Low	Maple	+40%	+13%
969	Warm Paldao, Quarter Cut, Slip-Matched	Low	Walnut	+15%	+5%
977	Chocolate Ash, Flat Cut, Book-Matched	Low	Ash		
978	Natural Oak, flat cut, book-matched	Low	Oak		
981	Champagne Hickory, Flat Cut, Book-Matched	Low	Oak		

### Exceptions

\* Only available with WL3 and WE3 edge detail.

# MP Tables

## Wood Finishes

# GEIGER

Wood Finishes		Upcharges			
Code	Description	Sheen	Solid	Excluding Hgt Adj Tables	Height Adjustable Tables
98R	Recograin Rosewood, Flat Cut, Slip-Matched *	Low	N/A		
98W	Recograin Walnut, Flat Cut, Slip-Matched *	Low	N/A	-5%	-2%
991	Champagne Ash, Flat Cut, Book-Matched	Low	Ash		
998	Ebony Ash, Flat Cut, Book-Matched	Low	Ash		
99A	Recograin Frosty Ash, Slip-Matched *	Low	N/A		
99K	Recograin Oak, Quarter Cut, Slip-Matched *	Low	N/A	-5%	-2%
99R	Recograin Rosewood, Quarter Cut, Slip-Matched *	Low	N/A		
99T	Recograin Teak, Quarter Cut, Slip-Matched *	Low	N/A		
99W	Recograin Walnut, Quarter Cut, Slip-Matched *	Low	N/A	-5%	-2%
9A1	White Ash, Quarter Cut, Slip-Matched	Low	Ash		
9K1	Rift Oak, Rift Cut, Slip-Matched	Low	Oak		
9K6	Burnt Oak, Rift Cut, Slip-Matched	Low	Oak		
ED	Aged Cherry, Flat Cut, Book-Matched	Low	Cherry		
EK	Medium Red Walnut, Flat Cut, Book-Matched	Low	Walnut		
ET	RecoGrain Ash, matte	Matte	N/A		
EU	RecoGrain Oak, matte	Matte	N/A		
EV	RecoGrain Walnut, matte	Matte	N/A		
G2U	Light Brown Walnut, Flat Cut, Book-Matched	Low	Walnut		
G40	Dark Brown Walnut, Flat Cut, Book-Matched	Low	Walnut		
UX	Walnut On Cherry, Flat Cut, Book-Matched	Low	Cherry		

### Exceptions

\* Only available with WL3 and WE3 edge detail.

### Notes

Natural wood finishes are unstained to maintain the natural beauty and clarity of the wood. When the veneer and solid wood species are not the same the veneer and solid may differ in color and graining. When a stained wood finish is specified, the solid wood edges are stained to match the veneer top as closely as possible.

Special finish colors may be developed for orders over \$200,000 list upon request at no additional charge. A one time set-up fee of \$250 net will be charged on orders under \$200,000 list for each special finish. In order to protect the quality and durability of Geiger's finish, the chemical composition of the staining materials, water-base sealers, and urethane top coats will not be altered for special finishes.

Exotic veneers such as pearwood, bird's eye maple and sycamore are available upon request, at additional cost.

For further information and procedures for special finishes or exotic veneers, contact your Geiger sales representative.

## Seating Capacity

Seating capacity is approximate, based on 25" wide chair, and may vary according to table base design and actual chair dimensions.

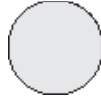

Table Size	No. Chairs
24" diameter	2
30" diameter	2
36" diameter	4
42" diameter	4
48" diameter	5



Table Size	No. Chairs
24" x 24"	4
30" x 30"	4
36" x 36"	4
42" x 42"	4
48" x 48"	4

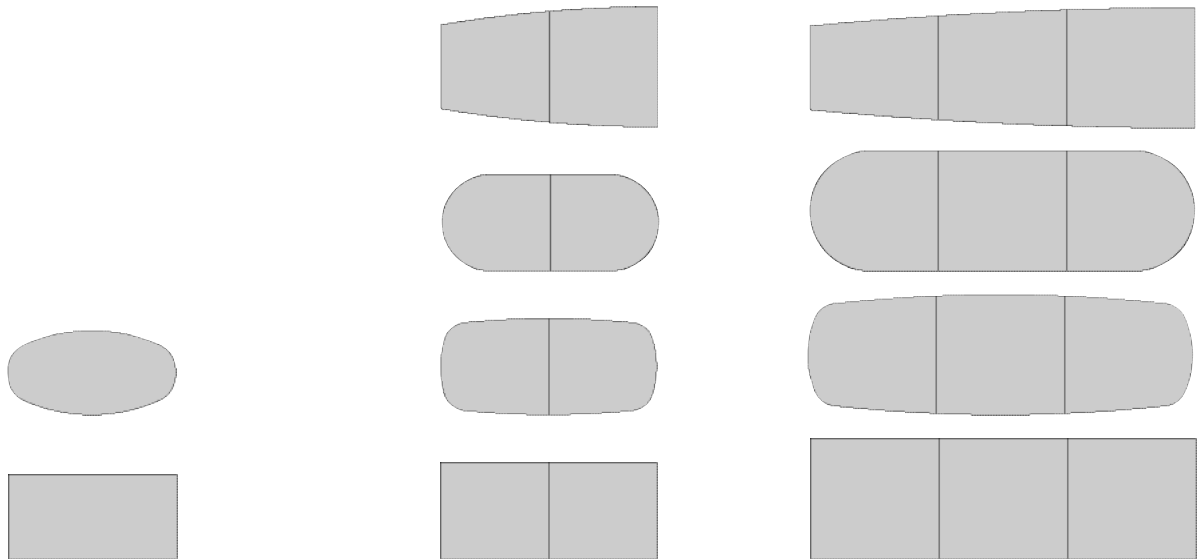

Table Size	No. Chairs
30" x 60"	4-6
30" x 66"	4-6
30" x 72"	6
36" x 60"	4-6
36" x 66"	4-6
36" x 72"	6
36" x 78"	6
36" x 84"	6-8
36" x 90"	6-8
36" x 96"	8
42" x 78"	6
42" x 84"	6-8
42" x 90"	6-8
42" x 96"	8
48" x 84"	6-8
48" x 90"	6-8
48" x 96"	8

Table Size	No. Chairs
42" x 108"	8-10
42" x 120"	10
42" x 132"	10
42" x 144"	10-12
42" x 156"	12
42" x 168"	12-14
42" x 180"	14
48" x 108"	8-10
48" x 120"	10
48" x 132"	10
48" x 144"	10-12
48" x 156"	12
48" x 168"	12-14
48" x 180"	14
54" x 108"	8-10
54" x 120"	10-12
54" x 132"	10-12
54" x 144"	10-12
54" x 156"	12-14
54" x 168"	12-14
54" x 180"	14-16
60" x 108"	10
60" x 120"	10-12
60" x 132"	10-12
60" x 144"	10-12
60" x 156"	12-14
60" x 168"	12-14
60" x 180"	14-16

Table Size	No. Chairs
42" x 192"	14
42" x 204"	14-16
42" x 216"	16
42" x 228"	16-18
42" x 240"	18
48" x 192"	14
48" x 204"	14-16
48" x 216"	16
48" x 228"	16-18
48" x 240"	18
54" x 192"	14-16
54" x 204"	16-18
54" x 216"	16-18
54" x 228"	18-20
54" x 240"	18-20
60" x 192"	14-16
60" x 204"	16-18
60" x 216"	16-18
60" x 228"	18
60" x 240"	18-20

### Flex Table Nesting

A single finger-pull mechanism at the front edge of each table releases the flip mechanism, allowing it to tilt to 90 degrees and lock into position. Tables can be rolled out of the way and nested with a 5-1/2" offset front to back and a 5" offset side to side. Rubber bumpers on the inside of the metal columns prevent damage to the adjacent table top when nested. Optional modesty panels are hinged, so as the table top is flipped into a nesting position, the modesty panel also eases into a nesting position.

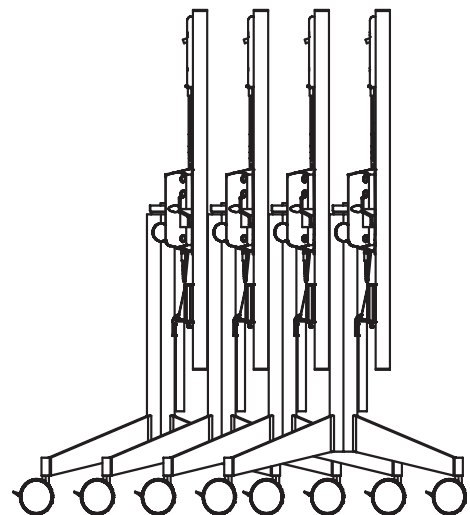
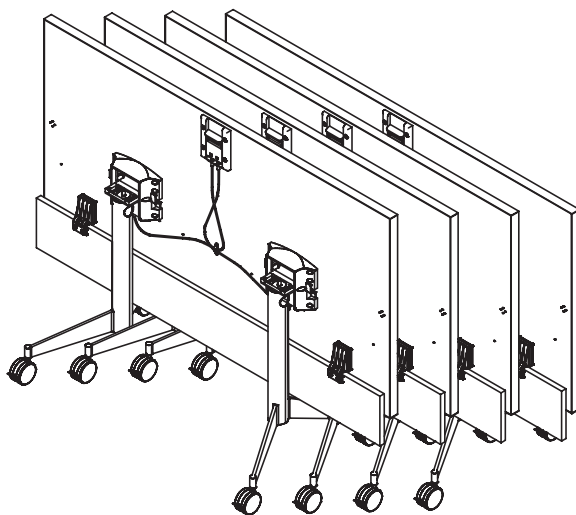
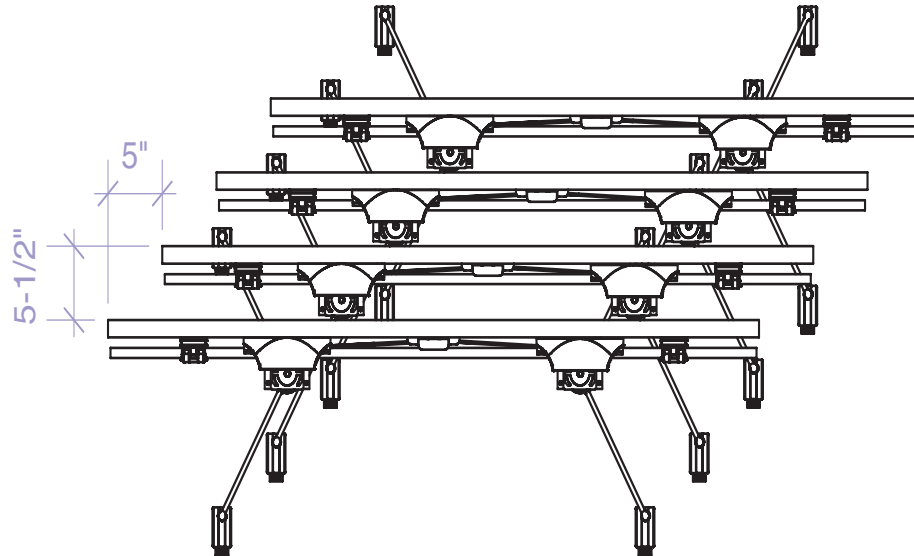

# MP Tables

## MP Flex Tables • Ganging

GEIGER

### Flex Table Ganging

MP Flex Tables can be joined using the MP Flex ganging bracket to form various conferencing/training configurations. Ganging brackets are ordered separately as needed. Order one AMGM-1 kit for each side connection and two AMGM-1 kits for each back to back connection. All rectangular, trapezoid and half-round tables are pre-drilled to accept ganging brackets. For best results, ganged tables should be installed on level floors.

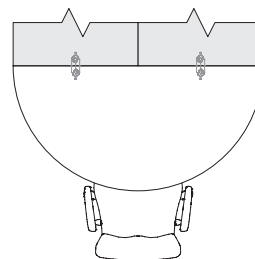
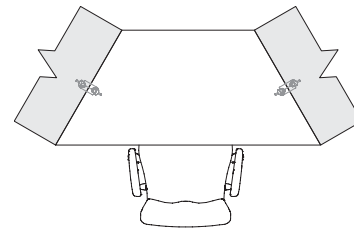
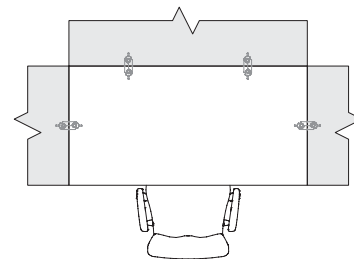
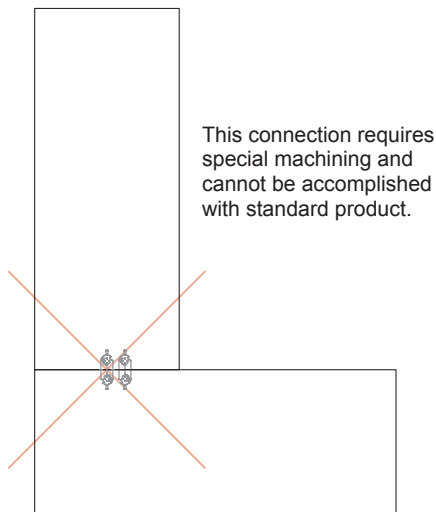
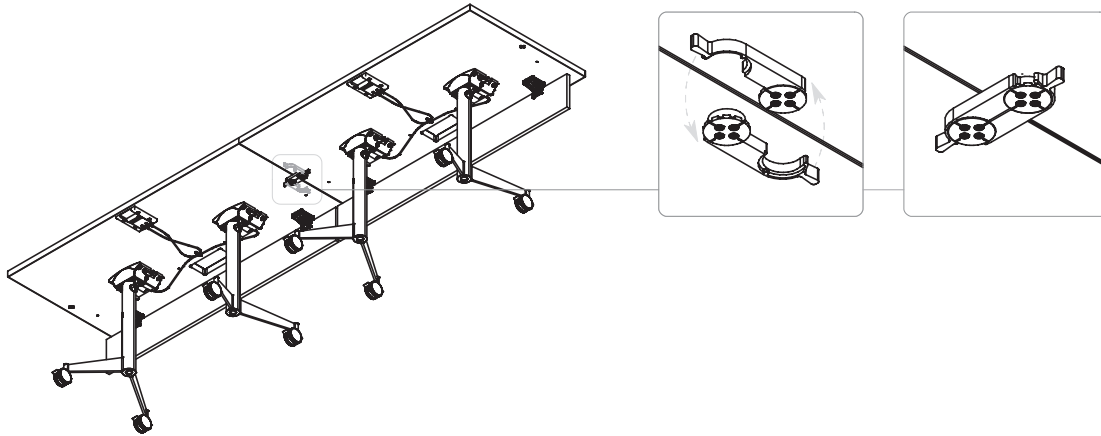

**Flex Table Modesty Panels**

MP Flex Tables can be ordered with an optional flip-down modesty panel in wood or laminate. Tops come pre-drilled to accept modesty panel brackets so modesty panels can be retrofitted at a later date as well. Modesty panels are field removable without the need for tools simply by depressing a lever tab on each bracket and sliding the panel off the brackets.

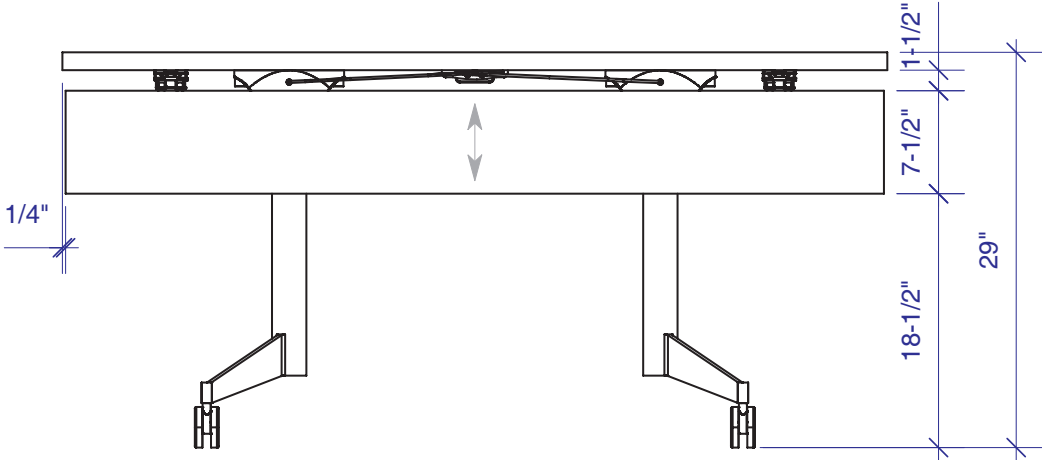
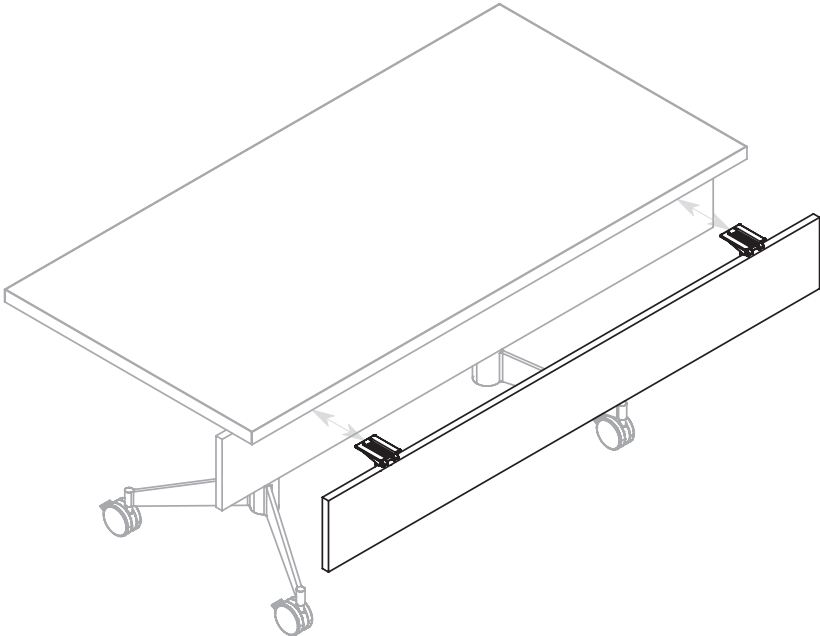



# MP Tables

## MP Flex Tables • Power

# GEIGER

### Flex Table Power

MP Flex Tables can be ordered with an optional tabletop power module covered by a fluid, one-touch door that remains open during use. Constructed of clear anodized aluminum, this unit consists of two power outlets and two slots for voice/data connections. It includes a voice/data adapter kit (A/V adapter kits and voice/data jacks sold separately). The power module is UL Listed and available with either a 15-amp cord or a modular, intelligent interlinking system allowing up to four tables (eight power modules or jumper cables) to be interconnected from a single infeed. This modular system includes an LED indicator that lights "green" when power is supplied and lights "red" when there are too many units linked together on a single power infeed.

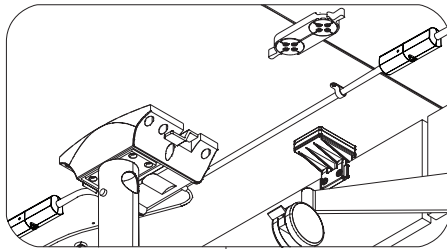

The Jumper Cable carries power across unpowered tables as well as extending power to the adjoining table as needed. When a table is specified with the interlinking connection system, it will ship with the appropriate jumper cable relative to the table's size.



Power Module  
(as seen from table top)

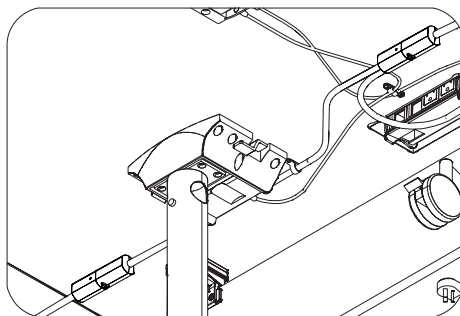
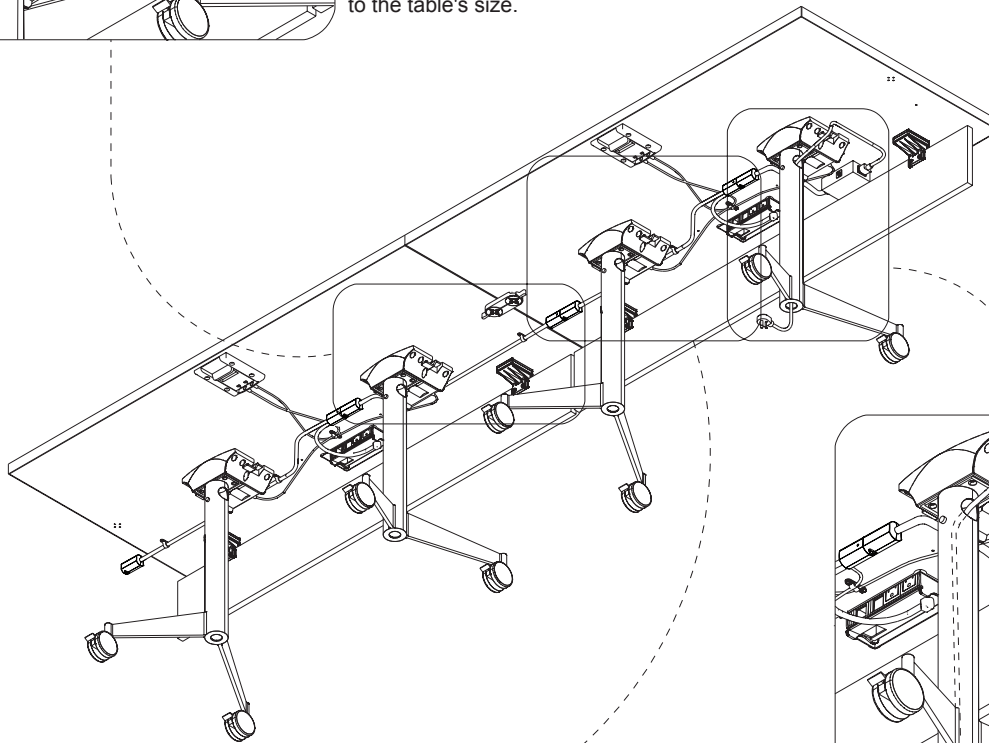

The Power Module includes a 12" cable with modular connector to join to either a Power Starter Kit or a Jumper Cable, and a longer, varying length cable with modular connector to join with an adjacent table's power.

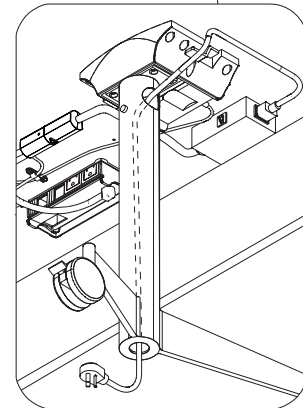

The Power Starter Kit brings power into the modular system and connects to the Power Module. The Power Starter Kit includes a 6' cable with three-prong plug which can be fed through a 1-1/2" hole at the top of the column, through the interior of the base and out a 2-3/8" hole at the bottom, creating a clean transition from tabletop to floor.

### Flex Table Sample Configurations

Samples shown have Arctic Silver bases, modular power components, ganging mechanisms and modesty panels (where applicable).

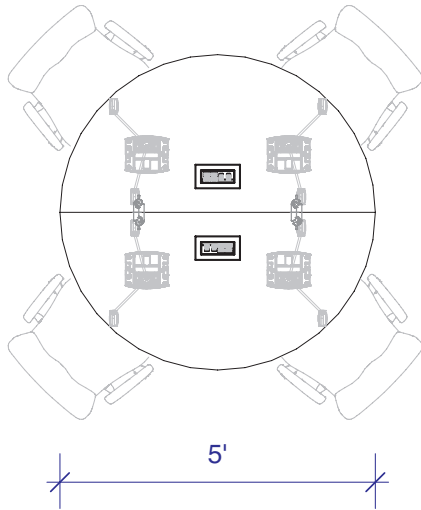

QTY	Description	Each	Ext Price
1	AMHWMP-60 30D x 60W x 29-1/4H MP Multi-Use, Half Round Table, Wood Top, Casters, Power Module	\$5,587	\$5,587
1	Power Starter Kit (Option)	\$411	\$411
1	AMHWMP-60 30D x 60W x 29-1/4H MP Multi-Use, Half Round Table, Wood Top, Casters, Power Module	\$5,587	\$5,587
1	Jumper Cable (Option)	\$148	\$148
2	AMGM-1 Ganging Kit	\$103	\$206
<b>Total</b>			<b>\$11,939</b>

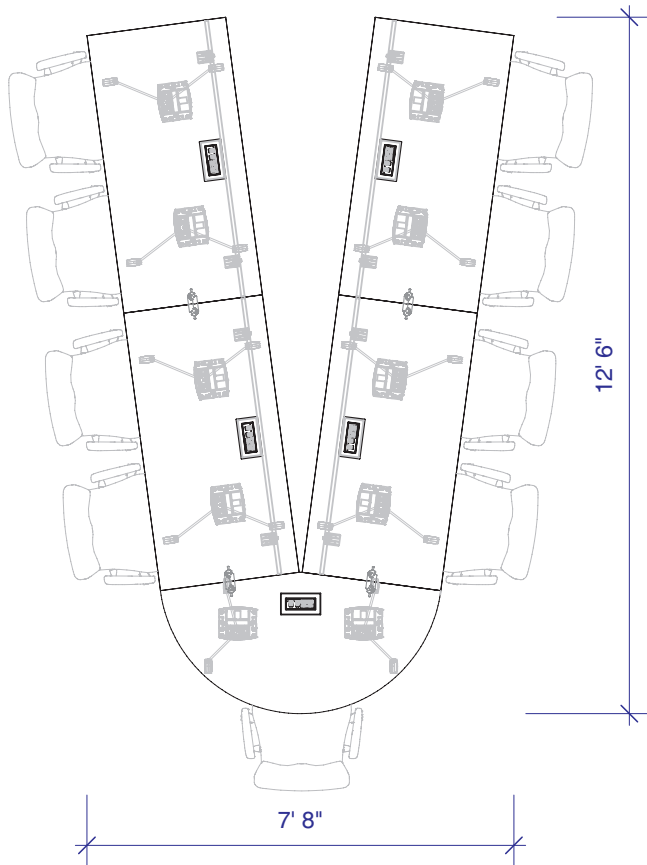

QTY	Description	Each	Ext Price
2	AM3WMP-3060 30D x 60W x 29-1/4H MP Multi-Use, Rectangular Table, Wood Top, Casters, Power Module	\$4,193	\$8,386
2	Power Starter Kit (Option)	\$411	\$822
2	AM3WMP-3060 30D x 60W x 29-1/4H MP Multi-Use, Rectangular Table, Wood Top, Casters, Power Module	\$4,193	\$8,386
2	Jumper Cable (Option)	\$148	\$296
1	AMVWMP-60 30D x 60W x 29-1/4H MP Multi-Use, Video Conf End Table, Wood Top, Casters, Power Module	\$5,773	\$5,773
1	Jumper Cable (Option)	\$144	\$144
4	AMMWM-60 3/4D x 59-1/2W x 7 1/2H MP Multi-Use Flip Down Modesty Panel, Wood	\$1,046	\$4,184
4	AMGM-1 Ganging Kit	\$103	\$412
<b>Total</b>			<b>\$28,403</b>

# MP Tables

## MP Flex Tables • Sample Configurations

# GEIGER

### Flex Table Sample Configurations

Samples shown have Arctic Silver bases, modular power components, ganging mechanisms and modesty panels (where applicable).

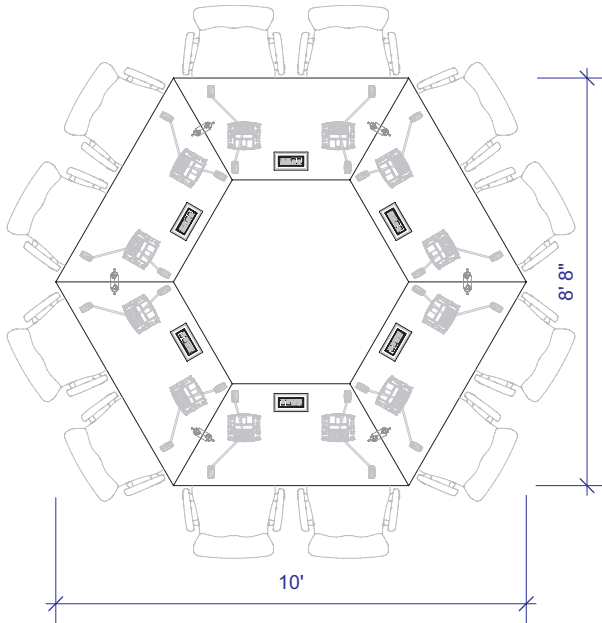

QTY	Description	Each	Ext Price
2	AMZWMP-2660 26D x 60W x 29-1/4H MP Multi-Use, Trapezoid Table, Wood Top, Casters, Power Module	\$5,773	\$11,546
2	Power Starter Kit (Option)	\$411	\$822
4	AMZWMP-2660 26D x 60W x 29-1/4H MP Multi-Use, Trapezoid Table, Wood Top, Casters, Power Module	\$5,773	\$23,092
4	Jumper Cable (Option)	\$148	\$592
6	AMGM-1 Ganging kit	\$103	\$618
6	AMMWM-30 3/4D x 29-1/2W x 7 1/2H MP Multi-Use Flip Down Modesty Panel, Wood	\$989	\$5,934
<b>Total</b>			<b>\$42,604</b>

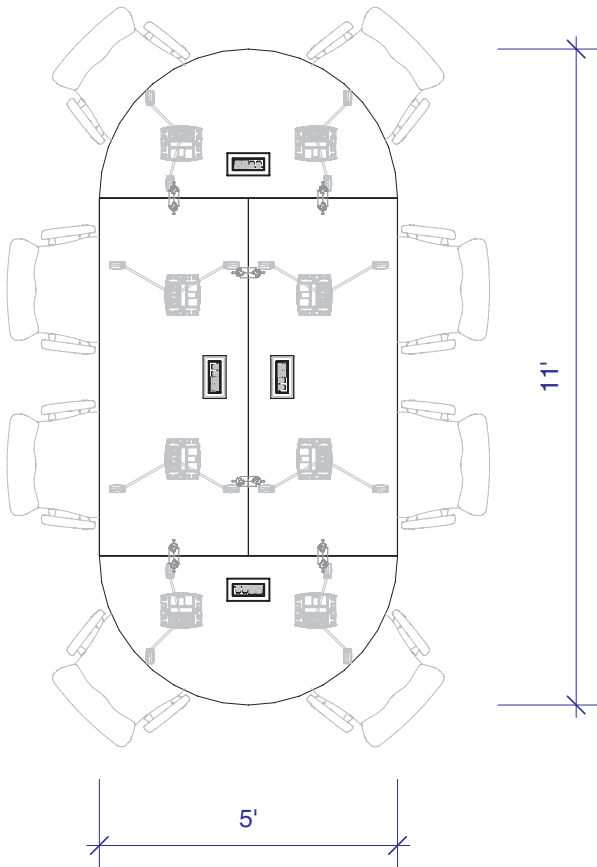

QTY	Description	Each	Ext Price
1	AMHWMP-60 30D x 60W x 29-1/4H MP Multi-Use, Half Round Table, Wood Top, Casters, Power Module	\$5,587	\$5,587
1	Power Starter Kit (Option)	\$411	\$411
1	AMHWMP-60 30D x 60W x 29-1/4H MP Multi-Use, Half Round Table, Wood Top, Casters, Power Module	\$5,587	\$5,587
1	Jumper Cable (Option)	\$148	\$148
2	AM3WMP-3060 30D x 60W x 29-1/4H MP Multi-Use, Rectangular Table, Wood Top, Casters, Power Module	\$5,501	\$11,002
2	Jumper Cable (Option)	\$148	\$296
4	AMGM-1 Ganging Kit	\$103	\$412
<b>Total</b>			<b>\$23,295</b>

### Flex Table Sample Configurations

Samples shown have Arctic Silver bases, modular power components, ganging mechanisms and modesty panels (where applicable).

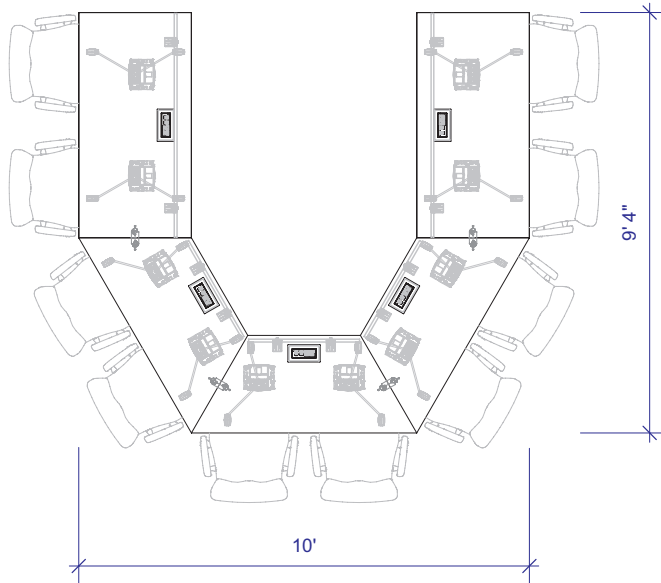

QTY	Description	Each	Ext Price
2	AM3WMP-3060 30D x 60W x 29-1/4H MP Multi-Use, Rectangular Table, Wood Top, Casters, Power Module	\$5,501	\$11,002
2	Power Starter Kit (Option)	\$411	\$822
3	AMZWMP-2660 26D x 60W x 29-1/4H MP Multi-Use, Trapezoid Table, Wood Top, Casters, Power Module	\$5,773	\$17,319
3	Jumper Cable (Option)	\$148	\$444
2	AMMW-60 3/4D x 59-1/2W x 7 1/2H MP Multi-Use Flip Down Modesty Panel, Wood	\$1,046	\$2,092
3	AMMW-30 3/4D x 29-1/2W x 7 1/2H MP Multi-Use Flip Down Modesty Panel, Wood	\$989	\$2,967
4	AMGM-1 Ganging Kit	\$103	\$412
<b>Total</b>			<b>\$35,058</b>

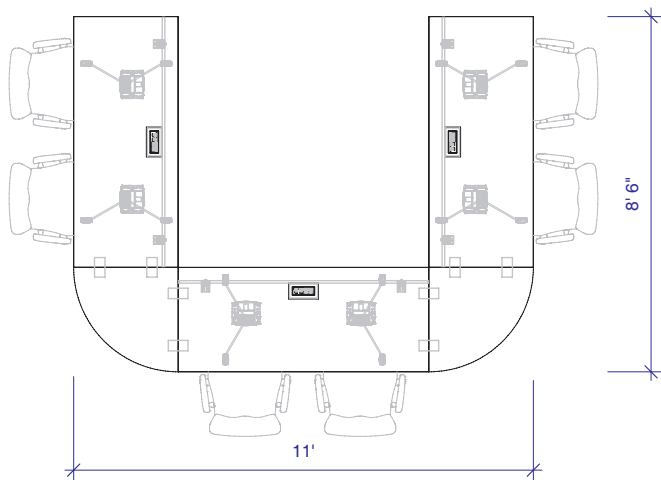

QTY	Description	Each	Ext Price
2	AM3WMP-3072 30D x 72W x 29-1/4H MP Multi-Use, Rectangular Table, Wood Top, Casters, Power Module	\$5,566	\$11,132
2	Power Starter Kit (Option)	\$411	\$822
1	AM3WMP-3072 30D x 72W x 29-1/4H MP Multi-Use, Rectangular Table, Wood Top, Casters, Power Module	\$5,566	\$5,566
1	Jumper Cable (Option)	\$148	\$148
3	AMMW-72 3/4D x 71-1/2W x 7 1/2H MP Multi-Use Flip Down Modesty Panel, Wood	\$1,082	\$3,246
2	AMCWMN-3030 30D x 30W x 1-1/4H MP Multi-Use, Rounded Corner, Wood Top Includes Flat Plates and Jumper Cable (Option)	\$1,964	\$3,928
2	Jumper Cable (Option)	\$148	\$296
<b>Total</b>			<b>\$25,138</b>

# MP Tables

Product Features • MP Height Adjustable Tables

# GEIGER

## MP Height Adjustable Tables Product Features

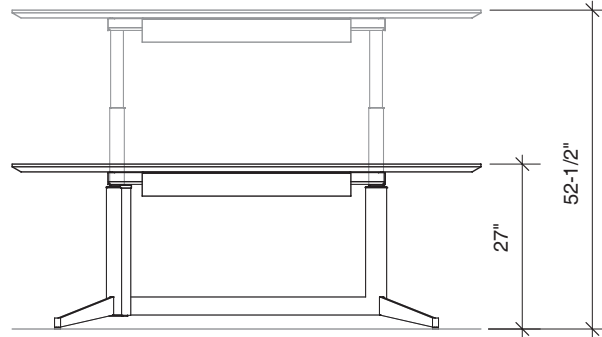

Each table includes a 4-outlet plug strip that can be specified with a 9' cord with a 3-prong plug or with knockouts for hardwiring in the field.

Each table comes standard with a hinged metal trough under the top between the base posts, secured with two latches, to conceal and manage cables.

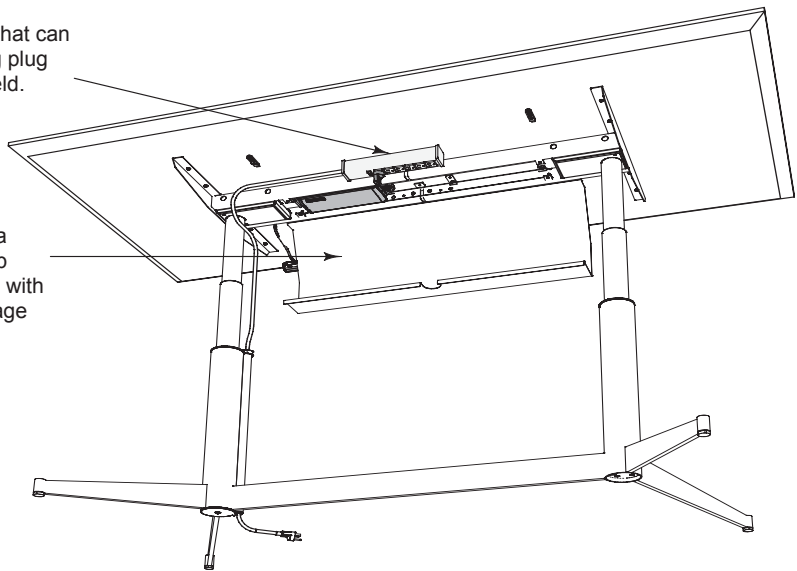

The controller is mounted on user side of the table and includes five buttons (up, down and 2 programmable presets and a lock feature). An LCD panel displays the height of the table. Additionally there are two USB ports on the side of the controller.

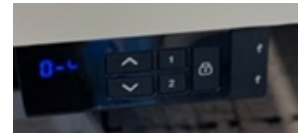

The optional modesty panel is available as a mitered three sided panel or a straight front panel in either a painted finish or vertical grained veneer.

The plug strip cord is managed from the top of the table base up to the plug strip by a flexible fabric sleeve which prevents the cable from sagging downwards as table height is adjusted.

The vertical cable manager conceals the plug strip cord alongside the table base. The finish matches that of the table base.

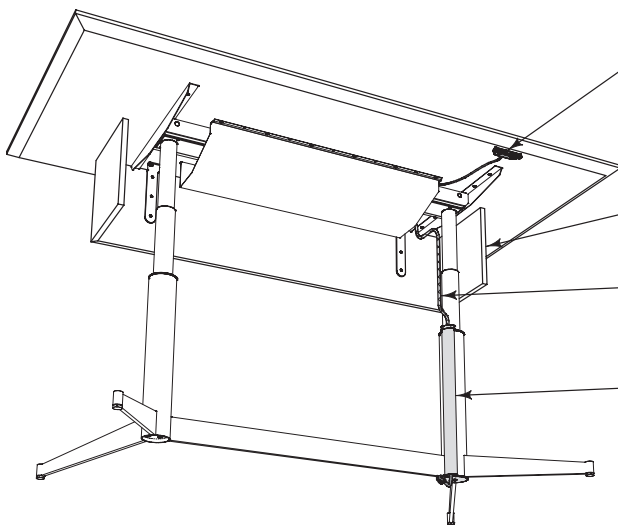

	Product Number	Depth	Width	Height	Basic Price	Base
<b>MP • Round</b> occasional height wood top  	<i>1 1/4" wood top</i>					
	<b>AM1WF-24</b>	24	24	16 1/4	\$1,807	+398
	<b>AM1WF-30</b>	30	30	16 1/4	\$2,103	+398
	<b>AM1WF-36</b>	36	36	16 1/4	\$2,374	+398
	<b>AM1WF-42</b>	42	42	16 1/4	\$2,899	+398
	<b>AM1WF-48</b>	48	48	16 1/4	\$3,278	+398

*Top.....wood veneered with specified edge detail*  
*Base .....metal*

<b>MP • Round</b> occasional height wood top with one grommet  	<i>1 1/4" wood top</i>					
	<b>AM1WH-24</b>	24	24	16 1/4	\$1,958	+398
	<b>AM1WH-30</b>	30	30	16 1/4	\$2,262	+398
	<b>AM1WH-36</b>	36	36	16 1/4	\$2,533	+398
	<b>AM1WH-42</b>	42	42	16 1/4	\$3,057	+398
	<b>AM1WH-48</b>	48	48	16 1/4	\$3,438	+398

*Top.....wood veneered with specified edge detail*  
*Base .....metal*

### Specify

- Wood
- Edge
- Base
- Grommet (for tables with grommets)

# MP Tables

Round • Glass Top • Occasional Height

# GEIGER

	Product Number	Depth	Width	Height	Basic Price	Base
<b>MP • Round</b> occasional height glass top  	<i>clear glass top</i>					
	<b>AM1CO-24</b>	24	24	16	\$2,648	+534
	<b>AM1CO-30</b>	30	30	16	\$2,985	+534
	<b>AM1CO-36</b>	36	36	16	\$3,180	+534
	<b>AM1CO-42</b>	42	42	16	\$3,733	+534
	<b>AM1CO-48</b>	48	48	16	\$4,100	+534
	<i>back-painted glass top</i>					
	<b>AM1BF-24</b>	24	24	16 1/4	\$2,733	+398
	<b>AM1BF-30</b>	30	30	16 1/4	\$3,223	+398
	<b>AM1BF-36</b>	36	36	16 1/4	\$3,876	+398
<b>AM1BF-42</b>	42	42	16 1/4	\$4,726	+398	
<b>AM1BF-48</b>	48	48	16 1/4	\$5,479	+398	

Clear glass top..... 1/2" thick low iron, non-tempered clear glass  
 Back-painted glass top ..... 1/2" thick low iron, back-painted glass with 3/4" thick painted MDF subtop  
 Base ..... metal

## Specify

Glass  
 Paint (for back-painted glass top tables)  
 Base

	Product Number	Depth	Width	Height	Basic Price	Base
<b>MP • Round</b> <i>lounge height</i> wood top 	<i>1 1/4" wood top</i>					
	<b>AM1WK-24</b>	24	24	26	\$1,843	+398
	<b>AM1WK-30</b>	30	30	26	\$2,160	+398
	<b>AM1WK-36</b>	36	36	26	\$2,433	+398
	<b>AM1WK-42</b>	42	42	26	\$2,979	+398
	<b>AM1WK-48</b>	48	48	26	\$3,361	+398

*Top.....wood veneered with specified edge detail*  
*Base .....metal*

	Product Number	Depth	Width	Height	Basic Price	Base
<b>MP • Round</b> <i>lounge height</i> wood top with one grommet 	<i>1 1/4" wood top</i>					
	<b>AM1WM-24</b>	24	24	26	\$2,002	+398
	<b>AM1WM-30</b>	30	30	26	\$2,310	+398
	<b>AM1WM-36</b>	36	36	26	\$2,590	+398
	<b>AM1WM-42</b>	42	42	26	\$3,135	+398
	<b>AM1WM-48</b>	48	48	26	\$3,516	+398

*Top.....wood veneered with specified edge detail*  
*Base .....metal*

**Specify**

- Wood
- Edge
- Base
- Grommet (for tables with grommets)



# MP Tables

Round • Glass Top • Lounge Height

# GEIGER

	Product Number	Depth	Width	Height	Basic Price	Base
<b>MP • Round</b> lounge height glass top  	<i>clear glass top</i>					
	<b>AM1CL-24</b>	24	24	25 3/4	\$2,749	+534
	<b>AM1CL-30</b>	30	30	25 3/4	\$3,057	+534
	<b>AM1CL-36</b>	36	36	25 3/4	\$3,246	+534
	<b>AM1CL-42</b>	42	42	25 3/4	\$3,803	+534
	<b>AM1CL-48</b>	48	48	25 3/4	\$4,171	+534
	<i>back-painted glass top</i>					
	<b>AM1BK-24</b>	24	24	26	\$2,770	+398
	<b>AM1BK-30</b>	30	30	26	\$3,278	+398
	<b>AM1BK-36</b>	36	36	26	\$3,933	+398
<b>AM1BK-42</b>	42	42	26	\$4,803	+398	
<b>AM1BK-48</b>	48	48	26	\$5,556	+398	

Clear glass top..... 1/2" thick low iron, non-tempered clear glass  
 Back-painted glass top..... 1/2" thick low iron, back-painted glass with 3/4" thick painted MDF subtop  
 Base ..... metal

## Specify

Glass  
 Paint (for back-painted glass top tables)  
 Base

	Product Number	Depth	Width	Height	Basic Price	Base
<b>MP • Round</b> desk height wood top	<i>1 1/4" wood top</i>					
	<b>AM1WB-30</b>	30	30	28 3/4	\$2,160	+398
	<b>AM1WB-36</b>	36	36	28 3/4	\$2,433	+398
	<b>AM1WB-42</b>	42	42	28 3/4	\$2,979	+398
	<b>AM1WB-48</b>	48	48	28 3/4	\$3,361	+398



*Top.....wood veneered with specified edge detail*  
*Base .....metal*

<b>MP • Round</b> desk height wood top with one grommet	<i>1 1/4" wood top</i>					
	<b>AM1WD-30</b>	30	30	28 3/4	\$2,310	+398
	<b>AM1WD-36</b>	36	36	28 3/4	\$2,590	+398
	<b>AM1WD-42</b>	42	42	28 3/4	\$3,135	+398
	<b>AM1WD-48</b>	48	48	28 3/4	\$3,516	+398



*Top.....wood veneered with specified edge detail*  
*Base .....metal*

### Specify

Wood  
 Edge  
 Base  
 Grommet (for tables with grommets)

# MP Tables

Round • Glass Top • Desk height

# GEIGER

	Product Number	Depth	Width	Height	Basic Price	Base
<b>MP • Round</b> desk height glass top  	<i>clear glass top</i>					
	<b>AM1CD-24</b>	24	24	28 1/2	\$2,749	+534
	<b>AM1CD-30</b>	30	30	28 1/2	\$3,057	+534
	<b>AM1CD-36</b>	36	36	28 1/2	\$3,246	+534
	<b>AM1CD-42</b>	42	42	28 1/2	\$3,803	+534
	<b>AM1CD-48</b>	48	48	28 1/2	\$4,171	+534
	<i>back-painted glass top</i>					
	<b>AM1BB-24</b>	24	24	28 3/4	\$2,770	+398
	<b>AM1BB-30</b>	30	30	28 3/4	\$3,278	+398
	<b>AM1BB-36</b>	36	36	28 3/4	\$3,933	+398
<b>AM1BB-42</b>	42	42	28 3/4	\$4,803	+398	
<b>AM1BB-48</b>	48	48	28 3/4	\$5,556	+398	

Clear glass top..... 1/2" thick low iron, non-tempered clear glass  
 Back-painted glass top..... 1/2" thick low iron, back-painted glass with 3/4" thick painted MDF subtop  
 Base ..... metal

## Specify

Glass  
 Paint (for back-painted glass top tables)  
 Base

	Product Number	Depth	Width	Height	Basic Price	Base
<b>MP • Round</b> café height wood top	<i>1 1/4" wood top</i>					
	<b>AM1WP-30</b>	30	30	42	\$2,267	+398
	<b>AM1WP-36</b>	36	36	42	\$2,540	+398
	<b>AM1WP-42</b>	42	42	42	\$3,051	+398
	<b>AM1WP-48</b>	48	48	42	\$3,423	+398



Top.....wood veneered with specified edge detail  
Base .....metal

<b>MP • Round</b> café height wood top with one grommet	<i>1 1/4" wood top</i>					
	<b>AM1WR-30</b>	30	30	42	\$2,426	+398
	<b>AM1WR-36</b>	36	36	42	\$2,698	+398
	<b>AM1WR-42</b>	42	42	42	\$3,207	+398
	<b>AM1WR-48</b>	48	48	42	\$3,583	+398



Top.....wood veneered with specified edge detail  
Base .....metal

### Specify

- Wood
- Edge
- Base
- Grommet (for tables with grommets)

# MP Tables

Round • Glass Top • Café Height

# GEIGER

	Product Number	Depth	Width	Height	Basic Price	Base
<b>MP • Round</b> café height glass top  	<i>clear glass top</i>					
	<b>AM1CC-24</b>	24	24	41 3/4	\$2,733	+534
	<b>AM1CC-30</b>	30	30	41 3/4	\$3,166	+534
	<b>AM1CC-36</b>	36	36	41 3/4	\$3,361	+534
	<b>AM1CC-42</b>	42	42	41 3/4	\$3,925	+534
	<b>AM1CC-48</b>	48	48	41 3/4	\$4,294	+534
	<i>back-painted glass top</i>					
	<b>AM1BP-30</b>	30	30	42	\$3,389	+398
	<b>AM1BP-36</b>	36	36	42	\$4,041	+398
	<b>AM1BP-42</b>	42	42	42	\$4,875	+398
<b>AM1BP-48</b>	48	48	42	\$5,630	+398	

Clear glass top..... 1/2" thick low iron, non-tempered clear glass  
 Back-painted glass top ..... 1/2" thick low iron, back-painted glass with 3/4" thick painted MDF subtop  
 Base ..... metal

## Specify

Glass  
 Paint (for back-painted glass top tables)  
 Base

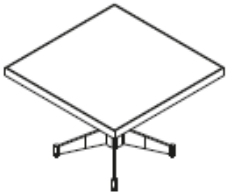
	Product Number	Depth	Width	Height	Basic Price	Base
<b>MP • Square</b> occasional height wood top 	<i>1 1/4" wood top</i>					
	<b>AM2WF-2424</b>	24	24	16 1/4	\$1,807	+398
	<b>AM2WF-3030</b>	30	30	16 1/4	\$2,103	+398
	<b>AM2WF-3636</b>	36	36	16 1/4	\$2,374	+398
	<b>AM2WF-4242</b>	42	42	16 1/4	\$2,899	+398
<b>AM2WF-4848</b>	48	48	16 1/4	\$3,278	+398	

*Top.....wood veneered with specified edge detail*  
*Base .....metal*

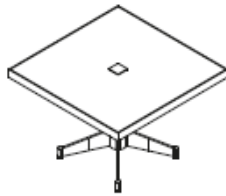
<b>MP • Square</b> occasional height wood top with one grommet 	<i>1 1/4" wood top</i>					
	<b>AM2WH-2424</b>	24	24	16 1/4	\$1,958	+398
	<b>AM2WH-3030</b>	30	30	16 1/4	\$2,262	+398
	<b>AM2WH-3636</b>	36	36	16 1/4	\$2,533	+398
	<b>AM2WH-4242</b>	42	42	16 1/4	\$3,057	+398
<b>AM2WH-4848</b>	48	48	16 1/4	\$3,438	+398	

*Top.....wood veneered with specified edge detail*  
*Base .....metal*

### Specify

Wood  
 Edge  
 Base  
 Grommet (for tables with grommets)

# MP Tables

Square • Glass Top • Occasional Height

# GEIGER

	Product Number	Depth	Width	Height	Basic Price		Base
<b>MP • Square</b> occasional height glass top  	<i>clear glass top</i>						
	<b>AM2CO-2424</b>	24	24	16	\$2,713		+534
	<b>AM2CO-3030</b>	30	30	16	\$2,972		+534
	<b>AM2CO-3636</b>	36	36	16	\$3,266		+534
	<b>AM2CO-4242</b>	42	42	16	\$3,826		+534
	<b>AM2CO-4848</b>	48	48	16	\$4,201		+534
	<i>back-painted glass top</i>						
	<b>AM2BF-2424</b>	24	24	16 1/4	\$2,733		+398
	<b>AM2BF-3030</b>	30	30	16 1/4	\$3,223		+398
	<b>AM2BF-3636</b>	36	36	16 1/4	\$3,876		+398
<b>AM2BF-4242</b>	42	42	16 1/4	\$4,726		+398	
<b>AM2BF-4848</b>	48	48	16 1/4	\$5,479		+398	

Clear glass top..... 1/2" thick low iron, non-tempered clear glass  
 Back-painted glass top ..... 1/2" thick low iron, back-painted glass with 3/4" thick painted MDF subtop  
 Base ..... metal

## Specify

Glass  
 Paint (for back-painted glass top tables)  
 Base

	Product Number	Depth	Width	Height	Basic Price	Base
<b>MP • Square</b> lounge height wood top	<i>1 1/4" wood top</i>					
	<b>AM2WK-2424</b>	24	24	26	\$1,843	+398
	<b>AM2WK-3030</b>	30	30	26	\$2,160	+398
	<b>AM2WK-3636</b>	36	36	26	\$2,433	+398
	<b>AM2WK-4242</b>	42	42	26	\$2,979	+398
	<b>AM2WK-4848</b>	48	48	26	\$3,361	+398

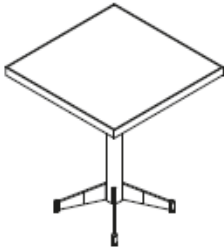

*Top.....wood veneered with specified edge detail*  
*Base .....metal*

<b>MP • Square</b> lounge height wood top with one grommet	<i>1 1/4" wood top</i>					
	<b>AM2WM-2424</b>	24	24	26	\$2,002	+398
	<b>AM2WM-3030</b>	30	30	26	\$2,310	+398
	<b>AM2WM-3636</b>	36	36	26	\$2,590	+398
	<b>AM2WM-4242</b>	42	42	26	\$3,135	+398
	<b>AM2WM-4848</b>	48	48	26	\$3,516	+398

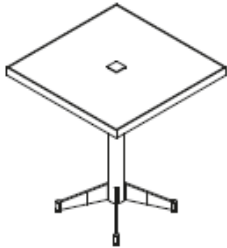

*Top.....wood veneered with specified edge detail*  
*Base .....metal*

### Specify

- Wood
- Edge
- Base
- Grommet (for tables with grommets)



# MP Tables

Square • Glass Top • Lounge Height

# GEIGER

	Product Number	Depth	Width	Height	Basic Price	Base
<b>MP • Square</b> lounge height glass top  	<i>clear glass top</i>					
	<b>AM2CL-2424</b>	24	24	25 3/4	\$2,815	+534
	<b>AM2CL-3030</b>	30	30	25 3/4	\$3,044	+534
	<b>AM2CL-3636</b>	36	36	25 3/4	\$3,337	+534
	<b>AM2CL-4242</b>	42	42	25 3/4	\$3,899	+534
	<b>AM2CL-4848</b>	48	48	25 3/4	\$4,263	+534
	<i>back-painted glass top</i>					
	<b>AM2BK-2424</b>	24	24	26	\$2,770	+398
	<b>AM2BK-3030</b>	30	30	26	\$3,278	+398
	<b>AM2BK-3636</b>	36	36	26	\$3,933	+398
<b>AM2BK-4242</b>	42	42	26	\$4,803	+398	
<b>AM2BK-4848</b>	48	48	26	\$5,556	+398	

Clear glass top..... 1/2" thick low iron, non-tempered clear glass  
 Back-painted glass top ..... 1/2" thick low iron, back-painted glass with 3/4" thick painted MDF subtop  
 Base ..... metal

## Specify

Glass  
 Paint (for back-painted glass top tables)  
 Base

	Product Number	Depth	Width	Height	Basic Price	Base
<b>MP • Square</b> desk height wood top	<i>1 1/4" wood top</i>					
	<b>AM2WB-3030</b>	30	30	28 3/4	\$2,160	+398
	<b>AM2WB-3636</b>	36	36	28 3/4	\$2,433	+398
	<b>AM2WB-4242</b>	42	42	28 3/4	\$2,979	+398
	<b>AM2WB-4848</b>	48	48	28 3/4	\$3,361	+398

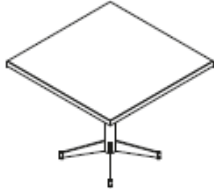

*Top.....wood veneered with specified edge detail*  
*Base .....metal*

	Product Number	Depth	Width	Height	Basic Price	Base
<b>MP • Square</b> desk height wood top with one grommet	<i>1 1/4" wood top</i>					
	<b>AM2WD-3030</b>	30	30	28 3/4	\$2,310	+364 +398
	<b>AM2WD-3636</b>	36	36	28 3/4	\$2,590	+437 +398
	<b>AM2WD-4242</b>	42	42	28 3/4	\$3,135	+510 +398
	<b>AM2WD-4848</b>	48	48	28 3/4	\$3,516	+582 +398



*Top.....wood veneered with specified edge detail*  
*Base .....metal*

### Specify

- Wood
- Edge
- Base
- Grommet (for tables with grommets)

# MP Tables

Square • Glass Top • Desk Height

# GEIGER

	Product Number	Depth	Width	Height	Basic Price	Base
<b>MP • Square</b> desk height glass top  	<i>clear glass top</i>					
	<b>AM2CD-2424</b>	24	24	28 1/2	\$2,815	+534
	<b>AM2CD-3030</b>	30	30	28 1/2	\$3,044	+534
	<b>AM2CD-3636</b>	36	36	28 1/2	\$3,337	+534
	<b>AM2CD-4242</b>	42	42	28 1/2	\$3,899	+534
	<b>AM2CD-4848</b>	48	48	28 1/2	\$4,263	+534
	<i>back-painted glass top</i>					
	<b>AM2BB-2424</b>	24	24	28 3/4	\$2,770	+398
	<b>AM2BB-3030</b>	30	30	28 3/4	\$3,278	+398
	<b>AM2BB-3636</b>	36	36	28 3/4	\$3,933	+398
<b>AM2BB-4242</b>	42	42	28 3/4	\$4,803	+398	
<b>AM2BB-4848</b>	48	48	28 3/4	\$5,556	+398	

Clear glass top..... 1/2" thick low iron, non-tempered clear glass  
 Back-painted glass top ..... 1/2" thick low iron, back-painted glass with 3/4" thick painted MDF subtop  
 Base ..... metal

## Specify

Glass  
 Paint (for back-painted glass top tables)  
 Base

	Product Number	Depth	Width	Height	Basic Price	Base
<b>MP • Square</b> café height wood top	<i>1 1/4" wood top</i>					
	<b>AM2WP-3030</b>	30	30	42	\$2,267	+398
	<b>AM2WP-3636</b>	36	36	42	\$2,540	+398
	<b>AM2WP-4242</b>	42	42	42	\$3,051	+398
	<b>AM2WP-4848</b>	48	48	42	\$3,423	+398



*Top.....wood veneered with specified edge detail  
Base .....metal*

<b>MP • Square</b> café height wood top with one grommet	<i>1 1/4" wood top</i>					
	<b>AM2WR-3030</b>	30	30	42	\$2,426	+398
	<b>AM2WR-3636</b>	36	36	42	\$2,698	+398
	<b>AM2WR-4242</b>	42	42	42	\$3,207	+398
	<b>AM2WR-4848</b>	48	48	42	\$3,583	+398



*Top.....wood veneered with specified edge detail  
Base .....metal*

### Specify

- Wood
- Edge
- Base
- Grommet (for tables with grommets)

# MP Tables

Square • Glass Top • Café Height

# GEIGER

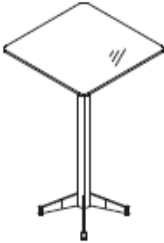
	Product Number	Depth	Width	Height	Basic Price	Base
<b>MP • Square</b> café height glass top  	<i>clear glass top</i>					
	<b>AM2CC-2424</b>	24	24	41 3/4	\$2,798	+534
	<b>AM2CC-3030</b>	30	30	41 3/4	\$3,152	+534
	<b>AM2CC-3636</b>	36	36	41 3/4	\$3,447	+534
	<b>AM2CC-4242</b>	42	42	41 3/4	\$4,027	+534
	<b>AM2CC-4848</b>	48	48	41 3/4	\$4,394	+534
	<i>back-painted glass top</i>					
	<b>AM2BP-3030</b>	30	30	42	\$3,389	+398
	<b>AM2BP-3636</b>	36	36	42	\$4,041	+398
	<b>AM2BP-4242</b>	42	42	42	\$4,875	+398
<b>AM2BP-4848</b>	48	48	42	\$5,630	+398	

Clear glass top..... 1/2" thick low iron, non-tempered clear glass  
 Back-painted glass top ..... 1/2" thick low iron, back-painted glass with 3/4" thick painted MDF subtop  
 Base ..... metal

## Specify

Glass  
 Paint (for back-painted glass top tables)  
 Base

	Product Number	Depth	Width	Height	Basic Price	Base
<b>MP • Rectangular</b> lounge height wood top, two bases  	<i>1 1/4" wood top</i>					
	<b>AM3WK-3060</b>	30	60	26	\$3,532	+766
	<b>AM3WK-3066</b>	30	66	26	\$3,675	+766
	<b>AM3WK-3072</b>	30	72	26	\$3,826	+766
	<b>AM3WK-3660</b>	36	60	26	\$3,784	+766
	<b>AM3WK-3666</b>	36	66	26	\$3,956	+766
	<b>AM3WK-3672</b>	36	72	26	\$4,128	+766
	<b>AM3WK-3678</b>	36	78	26	\$4,372	+766
	<b>AM3WK-3684</b>	36	84	26	\$4,549	+766
	<b>AM3WK-4278</b>	42	78	26	\$5,070	+766
	<b>AM3WK-4284</b>	42	84	26	\$5,269	+766

*Top..... wood veneered with specified edge detail*

*Base .....metal*

### Specify

Wood  
 Edge  
 Base

# MP Tables

Rectangular • Wood Top • Lounge Height

# GEIGER

	Product Number	Depth	Width	Height	Basic Price	Base
<b>MP • Rectangular</b> lounge height wood top with two grommets, two bases	<i>1 1/4" wood top</i>					
	<b>AM3WM-3060</b>	30	60	26 1/4	\$3,849	+766
	<b>AM3WM-3066</b>	30	66	26 1/4	\$3,992	+766
	<b>AM3WM-3072</b>	30	72	26 1/4	\$4,140	+766
	<b>AM3WM-3660</b>	36	60	26 1/4	\$4,091	+766
	<b>AM3WM-3666</b>	36	66	26 1/4	\$4,272	+766
	<b>AM3WM-3672</b>	36	72	26 1/4	\$4,444	+766
	<b>AM3WM-3678</b>	36	78	26 1/4	\$4,690	+766
	<b>AM3WM-3684</b>	36	84	26 1/4	\$4,868	+766
	<b>AM3WM-4278</b>	42	78	26 1/4	\$5,386	+766
	<b>AM3WM-4284</b>	42	84	26 1/4	\$5,587	+766



*Top.....wood veneered with specified edge detail*

*Base .....metal*

## Specify

- Wood
- Edge
- Base
- Grommet

	Product Number	Depth	Width	Height	Basic Price	Base
<b>MP • Rectangular</b> lounge height glass top, two bases 	<i>clear glass top</i>					
	<b>AM3CL-3060</b>	30	60	25 3/4	\$5,246	+890
	<b>AM3CL-3066</b>	30	66	25 3/4	\$5,479	+890
	<b>AM3CL-3072</b>	30	72	25 3/4	\$5,723	+890
	<b>AM3CL-3660</b>	36	60	25 3/4	\$5,572	+890
	<b>AM3CL-3666</b>	36	66	25 3/4	\$5,832	+890
	<b>AM3CL-3672</b>	36	72	25 3/4	\$6,119	+890

Clear glass top..... 1/2" thick low iron, non-tempered clear glass  
 Base ..... metal

**Specify**

Glass  
 Base



# MP Tables

Rectangular • Glass Top • Lounge Height

# GEIGER

	Product Number	Depth	Width	Height	Basic Price	Base
<b>MP • Rectangular</b> lounge height back-painted glass top, two bases 	<i>back-painted glass top</i>					
	<b>AM3BK-3060</b>	30	60	26	\$5,407	+766
	<b>AM3BK-3066</b>	30	66	26	\$5,679	+766
	<b>AM3BK-3072</b>	30	72	26	\$5,960	+766
	<b>AM3BK-3660</b>	36	60	26	\$5,911	+766
	<b>AM3BK-3666</b>	36	66	26	\$6,234	+766
	<b>AM3BK-3672</b>	36	72	26	\$6,554	+766
	<b>AM3BK-3678</b>	36	78	26	\$6,950	+766
	<b>AM3BK-3684</b>	36	84	26	\$7,281	+766
	<b>AM3BK-4278</b>	42	78	26	\$7,979	+766
	<b>AM3BK-4284</b>	42	84	26	\$8,129	+766

Back-painted glass top ..... 1/2" thick low iron, back-painted glass with 3/4" thick painted MDF subtop  
 Base ..... metal

## Specify

- Glass
- Paint
- Base

	Product Number	Depth	Width	Height	Basic Price	Base
<b>MP • Rectangular</b> desk height one-piece wood top, two bases  	<i>1 1/4" wood top</i>					
	<b>AM3WB-3060</b>	30	60	28 3/4	\$3,532	+766
	<b>AM3WB-3066</b>	30	66	28 3/4	\$3,675	+766
	<b>AM3WB-3072</b>	30	72	28 3/4	\$3,826	+766
	<b>AM3WB-3660</b>	36	60	28 3/4	\$3,784	+766
	<b>AM3WB-3666</b>	36	66	28 3/4	\$3,956	+766
	<b>AM3WB-3672</b>	36	72	28 3/4	\$4,128	+766
	<b>AM3WB-3678</b>	36	78	28 3/4	\$4,372	+766
	<b>AM3WB-3684</b>	36	84	28 3/4	\$4,549	+766
	<b>AM3WB-3690</b>	36	90	28 3/4	\$4,726	+766
	<b>AM3WB-3696</b>	36	96	28 3/4	\$4,897	+766
	<b>AM3WB-4278</b>	42	78	28 3/4	\$5,070	+766
	<b>AM3WB-4284</b>	42	84	28 3/4	\$5,269	+766
	<b>AM3WB-4290</b>	42	90	28 3/4	\$5,472	+766
	<b>AM3WB-4296</b>	42	96	28 3/4	\$5,673	+766
	<b>AM3WB-4884</b>	48	84	28 3/4	\$5,624	+766
	<b>AM3WB-4890</b>	48	90	28 3/4	\$5,844	+766
	<b>AM3WB-4896</b>	48	96	28 3/4	\$6,075	+766

Top..... wood veneered with specified edge detail

Base .....metal

Corners.....mitered

### Specify

Wood  
Edge  
Base

# MP Tables

Rectangular • Wood Top • Desk Height

# GEIGER

	Product Number	Depth	Width	Height	Basic Price	Base
<b>MP • Rectangular</b> desk height one-piece wood top with two grommets, two bases  	<i>1 1/4" wood top</i>					
	<b>AM3WD-3060</b>	30	60	28 3/4	\$3,849	+766
	<b>AM3WD-3066</b>	30	66	28 3/4	\$3,992	+766
	<b>AM3WD-3072</b>	30	72	28 3/4	\$4,140	+766
	<b>AM3WD-3660</b>	36	60	28 3/4	\$4,091	+766
	<b>AM3WD-3666</b>	36	66	28 3/4	\$4,272	+766
	<b>AM3WD-3672</b>	36	72	28 3/4	\$4,444	+766
	<b>AM3WD-3678</b>	36	78	28 3/4	\$4,690	+766
	<b>AM3WD-3684</b>	36	84	28 3/4	\$4,868	+766
	<b>AM3WD-3690</b>	36	90	28 3/4	\$5,041	+766
	<b>AM3WD-3696</b>	36	96	28 3/4	\$5,212	+766
	<b>AM3WD-4278</b>	42	78	28 3/4	\$5,386	+766
	<b>AM3WD-4284</b>	42	84	28 3/4	\$5,587	+766
	<b>AM3WD-4290</b>	42	90	28 3/4	\$5,783	+766
	<b>AM3WD-4296</b>	42	96	28 3/4	\$5,981	+766
	<b>AM3WD-4884</b>	48	84	28 3/4	\$5,938	+766
	<b>AM3WD-4890</b>	48	90	28 3/4	\$6,161	+766
	<b>AM3WD-4896</b>	48	96	28 3/4	\$6,385	+766

Top..... wood veneered with specified edge detail  
 Base ..... metal  
 Corners..... mitered

## Specify

- Wood
- Edge
- Base
- Grommet

	Product Number	Depth	Width	Height	Basic Price	Base
<b>MP • Rectangular</b> desk height two-piece wood top, two bases 	<i>1 1/4" wood top</i>					
	<b>AM3WF-42108</b>	42	108	28 3/4	\$6,808	+979
	<b>AM3WF-42120</b>	42	120	28 3/4	\$7,318	+979
	<b>AM3WF-48108</b>	48	108	28 3/4	\$7,097	+979
	<b>AM3WF-48120</b>	48	120	28 3/4	\$7,634	+979
	<b>AM3WF-54108</b>	54	108	28 3/4	\$7,728	+979
	<b>AM3WF-54120</b>	54	120	28 3/4	\$8,330	+979
	<b>AM3WF-60108</b>	60	108	28 3/4	\$8,050	+979
	<b>AM3WF-60120</b>	60	120	28 3/4	\$8,689	+979

*Top..... wood veneered with specified edge detail*

*Base ..... metal*

*Corners..... mitered*

### Specify

Wood  
 Edge  
 Base

	Product Number	Depth	Width	Height	Basic Price	Base
<b>MP • Rectangular</b> desk height two-piece wood top, three bases 	<i>1 1/4" wood top</i>					
	<b>AM3WF-42132</b>	42	132	28 3/4	\$9,401	+1,583
	<b>AM3WF-42144</b>	42	144	28 3/4	\$9,926	+1,583
	<b>AM3WF-42156</b>	42	156	28 3/4	\$10,484	+1,583
	<b>AM3WF-42168</b>	42	168	28 3/4	\$11,009	+1,583
	<b>AM3WF-42180</b>	42	180	28 3/4	\$11,528	+1,583
	<b>AM3WF-48132</b>	48	132	28 3/4	\$9,753	+1,583
	<b>AM3WF-48144</b>	48	144	28 3/4	\$10,307	+1,583
	<b>AM3WF-48156</b>	48	156	28 3/4	\$10,902	+1,583
	<b>AM3WF-48168</b>	48	168	28 3/4	\$11,456	+1,583
	<b>AM3WF-48180</b>	48	180	28 3/4	\$12,001	+1,583
	<b>AM3WF-54132</b>	54	132	28 3/4	\$10,536	+1,583
	<b>AM3WF-54144</b>	54	144	28 3/4	\$11,155	+1,583
	<b>AM3WF-54156</b>	54	156	28 3/4	\$11,815	+1,583
	<b>AM3WF-54168</b>	54	168	28 3/4	\$12,432	+1,583
	<b>AM3WF-54180</b>	54	180	28 3/4	\$13,042	+1,583
	<b>AM3WF-60132</b>	60	132	28 3/4	\$10,923	+1,583
	<b>AM3WF-60144</b>	60	144	28 3/4	\$11,579	+1,583
	<b>AM3WF-60156</b>	60	156	28 3/4	\$12,275	+1,583
	<b>AM3WF-60168</b>	60	168	28 3/4	\$12,927	+1,583
	<b>AM3WF-60180</b>	60	180	28 3/4	\$13,575	+1,583

Top.....wood veneered with specified edge detail  
 Base .....metal  
 Corners.....mitered

### Specify

Wood  
 Edge  
 Base

	Product Number	Depth	Width	Height	Basic Price	Base
<b>MP • Rectangular</b> desk height three-piece wood top, four bases 	<i>1 1/4" wood top</i>					
	<b>AM3WF-42192</b>	42	192	28 3/4	\$13,618	+2,189
	<b>AM3WF-42204</b>	42	204	28 3/4	\$14,186	+2,189
	<b>AM3WF-42216</b>	42	216	28 3/4	\$14,695	+2,189
	<b>AM3WF-42228</b>	42	228	28 3/4	\$15,221	+2,189
	<b>AM3WF-42240</b>	42	240	28 3/4	\$15,735	+2,189
	<b>AM3WF-48192</b>	48	192	28 3/4	\$14,128	+2,189
	<b>AM3WF-48204</b>	48	204	28 3/4	\$14,725	+2,189
	<b>AM3WF-48216</b>	48	216	28 3/4	\$15,271	+2,189
	<b>AM3WF-48228</b>	48	228	28 3/4	\$15,823	+2,189
	<b>AM3WF-48240</b>	48	240	28 3/4	\$16,370	+2,189
	<b>AM3WF-54192</b>	54	192	28 3/4	\$15,256	+2,189
	<b>AM3WF-54204</b>	54	204	28 3/4	\$15,916	+2,189
	<b>AM3WF-54216</b>	54	216	28 3/4	\$16,529	+2,189
	<b>AM3WF-54228</b>	54	228	28 3/4	\$17,138	+2,189
	<b>AM3WF-54240</b>	54	240	28 3/4	\$17,756	+2,189
	<b>AM3WF-60192</b>	60	192	28 3/4	\$15,815	+2,189
	<b>AM3WF-60204</b>	60	204	28 3/4	\$16,512	+2,189
	<b>AM3WF-60216</b>	60	216	28 3/4	\$17,159	+2,189
	<b>AM3WF-60228</b>	60	228	28 3/4	\$17,814	+2,189
	<b>AM3WF-60240</b>	60	240	28 3/4	\$18,460	+2,189

*Top..... wood veneered with specified edge detail*

*Base .....metal*

*Corners.....mitered*

### Specify

Wood  
Edge  
Base

	Product Number	Depth	Width	Height	Basic Price	Base
<b>MP • Rectangular</b> desk height glass top, two bases 	<i>clear glass top</i>					
	<b>AM3CD-3060</b>	30	60	28 1/2	\$5,246	+890
	<b>AM3CD-3066</b>	30	66	28 1/2	\$5,479	+890
	<b>AM3CD-3072</b>	30	72	28 1/2	\$5,723	+890
	<b>AM3CD-3660</b>	36	60	28 1/2	\$5,572	+890
	<b>AM3CD-3666</b>	36	66	28 1/2	\$5,832	+890
	<b>AM3CD-3672</b>	36	72	28 1/2	\$6,119	+890

Clear glass top..... 1/2" thick low iron, non-tempered clear glass  
 Base ..... metal

**Specify**

Glass  
 Base

# MP Tables

Rectangular • Back-Painted Glass Top • Desk Height

# GEIGER

	Product Number	Depth	Width	Height	Basic Price	Base
<b>MP • Rectangular</b>	<i>back-painted glass top</i>					
desk height	<b>AM3BB-3060</b>	30	60	28 3/4	\$5,407	+766
back-painted glass top, two bases	<b>AM3BB-3066</b>	30	66	28 3/4	\$5,679	+766
	<b>AM3BB-3072</b>	30	72	28 3/4	\$5,960	+766
	<b>AM3BB-3660</b>	36	60	28 3/4	\$5,911	+766
	<b>AM3BB-3666</b>	36	66	28 3/4	\$6,234	+766
	<b>AM3BB-3672</b>	36	72	28 3/4	\$6,554	+766
	<b>AM3BB-3678</b>	36	78	28 3/4	\$6,950	+766
	<b>AM3BB-3684</b>	36	84	28 3/4	\$7,281	+766
	<b>AM3BB-4278</b>	42	78	28 3/4	\$7,979	+766
	<b>AM3BB-4284</b>	42	84	28 3/4	\$8,129	+766





*Back-painted glass top ..... 1/2" thick low iron, back-painted glass with 3/4" thick painted MDF subtop  
Base ..... metal*

## Specify

- Glass
- Paint
- Base



	Product Number	Depth	Width	Height	Basic Price	Base
<b>MP • Oblong</b> lounge height wood top, two bases 	<i>1 1/4" wood top</i>					
	<b>AM5WK-3660</b>	36	60	26	\$3,784	+766
	<b>AM5WK-3666</b>	36	66	26	\$3,956	+766
	<b>AM5WK-3672</b>	36	72	26	\$4,128	+766
	<b>AM5WK-3678</b>	36	78	26	\$4,372	+766
	<b>AM5WK-4278</b>	42	78	26	\$5,070	+766
	<b>AM5WK-4284</b>	42	84	26	\$5,269	+766
	Top.....wood veneered with specified edge detail Base .....metal					

<b>MP • Oblong</b> lounge height wood top with two grommets, two bases 	<i>1 1/4" wood top</i>					
	<b>AM5WM-3660</b>	36	60	26	\$4,091	+766
	<b>AM5WM-3666</b>	36	66	26	\$4,272	+766
	<b>AM5WM-3672</b>	36	72	26	\$4,444	+766
	<b>AM5WM-3678</b>	36	78	26	\$4,690	+766
	<b>AM5WM-4278</b>	42	78	26	\$5,386	+766
	<b>AM5WM-4284</b>	42	84	26	\$5,587	+766
	Top.....wood veneered with specified edge detail Base .....metal					

### Specify

Wood  
 Edge  
 Base  
 Grommet (for tables with grommets)

# MP Tables

Oblong • Back-Painted Glass Top • Lounge Height

# GEIGER

	Product Number	Depth	Width	Height	Basic Price	Base
<b>MP • Oblong</b>	<i>back-painted glass top</i>					
lounge height	<b>AM5BK-3660</b>	36	60	26	\$5,911	+766
back-painted glass top, two bases	<b>AM5BK-3666</b>	36	66	26	\$6,234	+766
	<b>AM5BK-3672</b>	36	72	26	\$6,554	+766
	<b>AM5BK-3678</b>	36	78	26	\$6,950	+766
	<b>AM5BK-4278</b>	42	78	26	\$7,979	+766
	<b>AM5BK-4284</b>	42	84	26	\$8,357	+766



*Back-painted glass top ..... 1/2" thick low iron, back-painted glass with 3/4" thick painted MDF subtop  
Base ..... metal*

**Specify**

- Glass
- Paint
- Base

	Product Number	Depth	Width	Height	Basic Price	Base
<b>MP • Oblong</b> desk height wood top two bases 	<i>1 1/4" wood top</i>					
	<b>AM5WB-3660</b>	36	60	28 3/4	\$3,784	+766
	<b>AM5WB-3666</b>	36	66	28 3/4	\$3,956	+766
	<b>AM5WB-3672</b>	36	72	28 3/4	\$4,128	+766
	<b>AM5WB-3678</b>	36	78	28 3/4	\$4,372	+766
	<b>AM5WB-4278</b>	42	78	28 3/4	\$5,070	+766
	<b>AM5WB-4284</b>	42	84	28 3/4	\$5,269	+766
	<b>AM5WB-4290</b>	42	90	28 3/4	\$5,472	+766
	<b>AM5WB-4884</b>	48	84	28 3/4	\$5,624	+766
	<b>AM5WB-4890</b>	48	90	28 3/4	\$5,844	+766
	<b>AM5WB-4896</b>	48	96	28 3/4	\$6,075	+766

*Top..... wood veneered with specified edge detail*  
*Base ..... metal*  
*Corners..... radiused*

**Specify**

Wood  
 Edge  
 Base

# MP Tables

Oblong • Wood Top • Desk Height

# GEIGER

	Product Number	Depth	Width	Height	Basic Price	Base
<b>MP • Oblong</b> desk height wood top with two grommets, two bases <hr/> 	<i>1 1/4" wood top</i>					
	<b>AM5WD-3660</b>	36	60	28 3/4	\$4,091	+766
	<b>AM5WD-3666</b>	36	66	29	\$4,272	+766
	<b>AM5WD-3672</b>	36	72	29	\$4,444	+766
	<b>AM5WD-3678</b>	36	78	29	\$4,690	+766
	<b>AM5WD-4278</b>	42	78	29	\$5,386	+766
	<b>AM5WD-4284</b>	42	84	29	\$5,587	+766
	<b>AM5WD-4290</b>	42	90	29	\$5,783	+766
	<b>AM5WD-4884</b>	48	84	29	\$5,938	+766
	<b>AM5WD-4890</b>	48	90	29	\$6,161	+766
<b>AM5WD-4896</b>	48	96	29	\$6,385	+766	

*Top.....wood veneered with specified edge detail*

*Base .....metal*

*Corners.....radiused*

## Specify

- Wood
- Edge
- Base
- Grommet

	Product Number	Depth	Width	Height	Basic Price	Base
<b>MP • Oblong</b> desk height two-piece wood top, two bases	<i>1 1/4" wood top</i>					
	<b>AM8WF-48108</b>	48	108	28 3/4	\$7,097	+979
	<b>AM8WF-48120</b>	48	120	28 3/4	\$7,634	+979
	<b>AM8WF-54120</b>	54	120	28 3/4	\$8,330	+979
	<b>AM8WF-60120</b>	60	120	28 3/4	\$8,689	+979



*Top.....wood veneered with specified edge detail*  
*Base .....metal*  
*Corners.....radiused*

### Specify

Wood  
 Edge  
 Base

	Product Number	Depth	Width	Height	Basic Price	Base
<b>MP • Oblong</b> desk height two-piece wood top, three bases	<i>1 1/4" wood top</i>					
	<b>AM8WF-54132</b>	54	132	28 3/4	\$10,578	+1,583
	<b>AM8WF-54144</b>	54	144	28 3/4	\$11,190	+1,583
	<b>AM8WF-54156</b>	54	156	28 3/4	\$11,859	+1,583
	<b>AM8WF-54168</b>	54	168	28 3/4	\$12,470	+1,583
	<b>AM8WF-60132</b>	60	132	28 3/4	\$10,967	+1,583
	<b>AM8WF-60144</b>	60	144	28 3/4	\$11,612	+1,583
	<b>AM8WF-60156</b>	60	156	28 3/4	\$12,318	+1,583
	<b>AM8WF-60168</b>	60	168	28 3/4	\$12,965	+1,583
	<b>AM8WF-60180</b>	60	180	28 3/4	\$13,618	+1,583



*Top.....wood veneered with specified edge detail*

*Base .....metal*

*Corners.....radiused*

### Specify

Wood  
 Edge  
 Base

	Product Number	Depth	Width	Height	Basic Price	Base
<b>MP • Oblong</b> desk height three-piece wood top, four bases	<i>1 1/4" wood top</i>					
	<b>AM8WF-60192</b>	60	192	28 3/4	\$15,895	+2,189
	<b>AM8WF-60204</b>	60	204	28 3/4	\$16,599	+2,189
	<b>AM8WF-60216</b>	60	216	28 3/4	\$17,239	+2,189
	<b>AM8WF-60228</b>	60	228	28 3/4	\$17,891	+2,189
<b>AM8WF-60240</b>	60	240	28 3/4	\$18,538	+2,189	



Top.....wood veneered with specified edge detail

Base .....metal

Corners.....radiused

### Specify

Wood  
 Edge  
 Base  
 Power

# MP Tables

Oblong • Glass Top • Desk Height

# GEIGER

	Product Number	Depth	Width	Height	Basic Price	Base
<b>MP • Oblong</b> desk height glass top, two bases	<i>back-painted glass top</i>					
	<b>AM5BB-3660</b>	36	60	28 3/4	\$5,911	+766
	<b>AM5BB-3666</b>	36	66	28 3/4	\$6,234	+766
	<b>AM5BB-3672</b>	36	72	28 3/4	\$6,554	+766
	<b>AM5BB-3678</b>	36	78	28 3/4	\$6,950	+766
	<b>AM5BB-4278</b>	42	78	28 3/4	\$7,979	+766
	<b>AM5BB-4284</b>	42	84	28 3/4	\$8,357	+766



*Back-painted glass top ..... 1/2" thick low iron, back-painted glass with 3/4" thick painted MDF subtop*  
*Base ..... metal*

## Specify

- Glass
- Paint
- Base

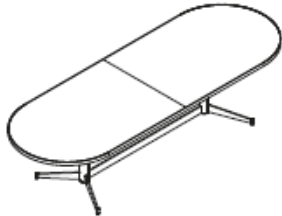

	Product Number	Depth	Width	Height	Basic Price	Base
<b>MP • Racetrack</b> desk height two-piece wood top, two bases  	<i>1 1/4" wood top</i>					
	<b>AM4WF-42120</b>	42	120	28 3/4	\$7,031	+979
	<b>AM4WF-42132</b>	42	132	28 3/4	\$7,539	+979
	<b>AM4WF-48120</b>	48	120	28 3/4	\$7,346	+979
	<b>AM4WF-48132</b>	48	132	28 3/4	\$7,890	+979
	<b>AM4WF-54120</b>	54	120	28 3/4	\$8,050	+979
	<b>AM4WF-54132</b>	54	132	28 3/4	\$8,655	+979
	<b>AM4WF-60120</b>	60	120	28 3/4	\$8,403	+979
	<b>AM4WF-60132</b>	60	132	28 3/4	\$9,042	+979

*Top.....wood veneered with specified edge detail*

*Base .....metal*

*Corners.....radiused*

### Specify

Wood  
Edge  
Base

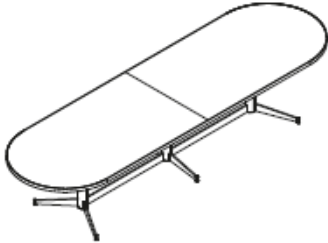
	Product Number	Depth	Width	Height	Basic Price	Base
<b>MP • Racetrack</b> desk height two-piece wood top, three bases  	<i>1 1/4" wood top</i>					
	<b>AM4WF-42144</b>	42	144	28 3/4	\$9,623	+1,583
	<b>AM4WF-42156</b>	42	156	29	\$10,141	+1,583
	<b>AM4WF-42168</b>	42	168	29	\$10,717	+1,583
	<b>AM4WF-42180</b>	42	180	29	\$11,232	+1,583
	<b>AM4WF-48144</b>	48	144	29	\$10,003	+1,583
	<b>AM4WF-48156</b>	48	156	29	\$10,558	+1,583
	<b>AM4WF-48168</b>	48	168	29	\$11,161	+1,583
	<b>AM4WF-48180</b>	48	180	29	\$11,705	+1,583
	<b>AM4WF-54144</b>	54	144	29	\$10,859	+1,583
	<b>AM4WF-54156</b>	54	156	29	\$11,470	+1,583
	<b>AM4WF-54168</b>	54	168	29	\$12,136	+1,583
	<b>AM4WF-54180</b>	54	180	29	\$12,750	+1,583
	<b>AM4WF-60144</b>	60	144	29	\$11,283	+1,583
	<b>AM4WF-60156</b>	60	156	29	\$11,928	+1,583
	<b>AM4WF-60168</b>	60	168	29	\$12,626	+1,583
	<b>AM4WF-60180</b>	60	180	29	\$13,280	+1,583

*Top..... wood veneered with specified edge detail*

*Base .....metal*

*Corners.....radiused*

### Specify

Wood  
Edge  
Base

	Product Number	Depth	Width	Height	Basic Price	Base
<b>MP • Racetrack</b> desk height three-piece wood top, four bases 	<i>1 1/4" wood top</i>					
	<b>AM4WF-42192</b>	42	192	28 3/4	\$13,323	+2,189
	<b>AM4WF-42204</b>	42	204	29	\$13,840	+2,189
	<b>AM4WF-42216</b>	42	216	29	\$14,408	+2,189
	<b>AM4WF-42228</b>	42	228	29	\$14,918	+2,189
	<b>AM4WF-42240</b>	42	240	29	\$15,441	+2,189
	<b>AM4WF-48192</b>	48	192	29	\$13,832	+2,189
	<b>AM4WF-48204</b>	48	204	29	\$14,380	+2,189
	<b>AM4WF-48216</b>	48	216	29	\$14,983	+2,189
	<b>AM4WF-48228</b>	48	228	29	\$15,522	+2,189
	<b>AM4WF-48240</b>	48	240	29	\$16,075	+2,189
	<b>AM4WF-54192</b>	54	192	29	\$14,960	+2,189
	<b>AM4WF-54204</b>	54	204	29	\$15,571	+2,189
	<b>AM4WF-54216</b>	54	216	29	\$16,240	+2,189
	<b>AM4WF-54228</b>	54	228	29	\$16,843	+2,189
	<b>AM4WF-54240</b>	54	240	29	\$17,453	+2,189
	<b>AM4WF-60192</b>	60	192	29	\$15,522	+2,189
	<b>AM4WF-60204</b>	60	204	29	\$16,173	+2,189
	<b>AM4WF-60216</b>	60	216	29	\$16,872	+2,189
	<b>AM4WF-60228</b>	60	228	29	\$17,512	+2,189
<b>AM4WF-60240</b>	60	240	29	\$18,165	+2,189	

Top..... wood veneered with specified edge detail

Base ..... metal

Corners..... radiused

### Specify

Wood  
 Edge  
 Base

	Product Number	Depth	Width	Height	Basic Price	Base
<b>MP • Half Boat</b>	<i>1 1/4" wood top</i>					
desk height	<b>AM9WF-60108</b>	60	108	28 3/4	\$8,077	+979
two-piece wood top, two bases	<b>AM9WF-60120</b>	60	120	28 3/4	\$8,719	+979



*Top..... wood veneered with specified edge detail*  
*Base .....metal*  
*Corners.....mitered*

### Specify

Wood  
 Edge  
 Base

	Product Number	Depth	Width	Height	Basic Price	Base
<b>MP • Half Boat</b> desk height two-piece wood top, three bases	<i>1 1/4" wood top</i>					
	<b>AM9WF-60132</b>	60	132	28 3/4	\$10,959	+1,583
	<b>AM9WF-60144</b>	60	144	28 3/4	\$11,607	+1,583
	<b>AM9WF-60156</b>	60	156	28 3/4	\$12,312	+1,583
	<b>AM9WF-60168</b>	60	168	28 3/4	\$12,955	+1,583
	<b>AM9WF-60180</b>	60	180	28 3/4	\$13,610	+1,583



*Top..... wood veneered with specified edge detail*  
*Base ..... metal*  
*Corners..... mitered*

### Specify

Wood  
 Edge  
 Base

	Product Number	Depth	Width	Height	Basic Price	Base
<b>MP • Half Boat</b> desk height three-piece wood top, four bases	<i>1 1/4" wood top</i>					
	<b>AM9WF-60192</b>	60	192	28 3/4	\$15,887	+2,189
	<b>AM9WF-60204</b>	60	204	28 3/4	\$16,591	+2,189
	<b>AM9WF-60216</b>	60	216	28 3/4	\$17,230	+2,189
	<b>AM9WF-60228</b>	60	228	28 3/4	\$17,878	+2,189
	<b>AM9WF-60240</b>	60	240	28 3/4	\$18,532	+2,189

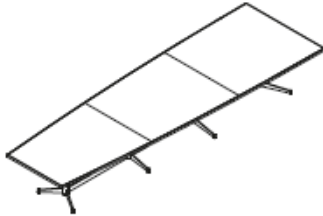

*Top..... wood veneered with specified edge detail*  
*Base ..... metal*  
*Corners..... mitered*

### Specify

Wood  
 Edge  
 Base

	Product Number	Depth	Width	Height	Basic Price	Base
<b>MP • Rectangular</b> plain wood top  	<b>AM3WMN-2460</b>	24	60	29	\$4,279	+593
	<b>AM3WMN-2466</b>	24	66	29	\$4,315	+593
	<b>AM3WMN-2472</b>	24	72	29	\$4,343	+593
	<b>AM3WMN-3060</b>	30	60	29	\$4,439	+593
	<b>AM3WMN-3066</b>	30	66	29	\$4,465	+593
	<b>AM3WMN-3072</b>	30	72	29	\$4,495	+593
	<b>AM3WMN-3078</b>	30	78	29	\$4,523	+593
	<b>AM3WMN-3084</b>	30	84	29	\$4,560	+593
	<b>AM3WMN-3672</b>	36	72	29	\$4,574	+593
	<b>AM3WMN-3678</b>	36	78	29	\$4,602	+593
	<b>AM3WMN-3684</b>	36	84	29	\$4,631	+593

Top.....1 1/4" thick wood veneered with WE3 eased edge detail  
 Base .....metal  
 Corners.....mitered  
 Casters .....soft or hard, black

**Note:** Flex tables come pre-drilled for modesty panels and ganging brackets.  
 Specify ganging brackets and modesty panels separately.

### Specify

Wood  
 Edge (available in WE3 only)  
 Base  
 Casters

# MP Flex Tables

Rectangular • Laminate Top

GEIGER



	Product Number	Depth	Width	Height	Basic Price	Base
<b>MP • Rectangular</b> plain laminate top	<b>AM3LMN-2460</b>	24	60	29	\$3,668	+593
	<b>AM3LMN-2466</b>	24	66	29	\$3,705	+593
	<b>AM3LMN-2472</b>	24	72	29	\$3,733	+593
	<b>AM3LMN-3060</b>	30	60	29	\$3,826	+593
	<b>AM3LMN-3066</b>	30	66	29	\$3,854	+593
	<b>AM3LMN-3072</b>	30	72	29	\$3,884	+593
	<b>AM3LMN-3078</b>	30	78	29	\$3,913	+593
	<b>AM3LMN-3084</b>	30	84	29	\$3,947	+593
	<b>AM3LMN-3672</b>	36	72	29	\$3,963	+593
	<b>AM3LMN-3678</b>	36	78	29	\$3,992	+593
	<b>AM3LMN-3684</b>	36	84	29	\$4,021	+593

Top..... 1 1/8" thick laminate top with (ECE) PVC eased edge detail  
 Base ..... metal  
 Corners..... mitered  
 Casters ..... soft or hard, black

**Note:** Flex tables come pre-drilled for modesty panels and ganging brackets.  
 Specify ganging brackets and modesty panels separately.

**Specify**

- Edge (available in ECE only)
- Base
- Casters
- Laminate





	Product Number	Depth	Width	Height	Basic Price	Base
<b>MP • Rectangular</b> wood top with large grommet	<b>AM3WMG-2460</b>	24	60	29	\$4,666	+593
	<b>AM3WMG-2466</b>	24	66	29	\$4,695	+593
	<b>AM3WMG-2472</b>	24	72	29	\$4,726	+593
	<b>AM3WMG-3060</b>	30	60	29	\$4,816	+593
	<b>AM3WMG-3066</b>	30	66	29	\$4,847	+593
	<b>AM3WMG-3072</b>	30	72	29	\$4,875	+593
	<b>AM3WMG-3078</b>	30	78	29	\$4,903	+593
	<b>AM3WMG-3084</b>	30	84	29	\$4,941	+593
	<b>AM3WMG-3672</b>	36	72	29	\$4,953	+593
	<b>AM3WMG-3678</b>	36	78	29	\$4,982	+593
	<b>AM3WMG-3684</b>	36	84	29	\$5,012	+593

Top.....1 1/4" thick wood veneered with WE3 eased edge detail  
 Base .....metal  
 Corners.....mitered  
 Casters .....soft or hard, black

**Note:** Flex tables come pre-drilled for modesty panels and ganging brackets.  
 Specify ganging brackets and modesty panels separately.

**Specify**

- Wood
- Edge (available in WE3 only)
- Metal (grommet finish) Base
- Casters

# MP Flex Tables

Rectangular • Laminate Top with Grommet

# GEIGER

	Product Number	Depth	Width	Height	Basic Price	Base
<b>MP • Rectangular</b> laminate top with large grommet  	<b>AM3LMG-2460</b>	24	60	29	\$4,056	+593
	<b>AM3LMG-2466</b>	24	66	29	\$4,086	+593
	<b>AM3LMG-2472</b>	24	72	29	\$4,113	+593
	<b>AM3LMG-3060</b>	30	60	29	\$4,207	+593
	<b>AM3LMG-3066</b>	30	66	29	\$4,236	+593
	<b>AM3LMG-3072</b>	30	72	29	\$4,263	+593
	<b>AM3LMG-3078</b>	30	78	29	\$4,299	+593
	<b>AM3LMG-3084</b>	30	84	29	\$4,328	+593
	<b>AM3LMG-3672</b>	36	72	29	\$4,343	+593
	<b>AM3LMG-3678</b>	36	78	29	\$4,372	+593
	<b>AM3LMG-3684</b>	36	84	29	\$4,400	+593

Top..... 1 1/8" thick laminate top with (ECE) PVC eased edge detail

Base .....metal

Corners..... mitered

Casters ..... soft or hard, black

**Note:** Flex tables come pre-drilled for modesty panels and ganging brackets. Specify ganging brackets and modesty panels separately.

### Specify

Edge (available in ECE only)

Metal (grommet finish)

Base

Casters

Laminate

	Product Number	Depth	Width	Height	Basic Price	Base
<b>MP • Rectangular</b> wood top with power  	<b>AM3WMP-2460</b>	24	60	29	\$5,349	+593
	<b>AM3WMP-2466</b>	24	66	29	\$5,379	+593
	<b>AM3WMP-2472</b>	24	72	29	\$5,407	+593
	<b>AM3WMP-3060</b>	30	60	29	\$5,501	+593
	<b>AM3WMP-3066</b>	30	66	29	\$5,528	+593
	<b>AM3WMP-3072</b>	30	72	29	\$5,566	+593
	<b>AM3WMP-3078</b>	30	78	29	\$5,595	+593
	<b>AM3WMP-3084</b>	30	84	29	\$5,624	+593
	<b>AM3WMP-3672</b>	36	72	29	\$5,637	+593
	<b>AM3WMP-3678</b>	36	78	29	\$5,673	+593
	<b>AM3WMP-3684</b>	36	84	29	\$5,702	+593

Top.....1 1/4" thick wood veneered with WE3 eased edge detail  
 Base .....metal  
 Corners.....mitered  
 Casters .....soft or hard, black

**Note:** Flex tables come pre-drilled for modesty panels and ganging brackets.  
 Specify ganging brackets and modesty panels separately.

Table includes one power module and one jumper cable.

### Specify

- Wood
- Edge (available in WE3 only)
- Base
- Power
- Casters

# MP Flex Tables

Rectangular • Laminate Top with Power

# GEIGER

	Product Number	Depth	Width	Height	Basic Price	Base
 <p><b>MP • Rectangular</b> laminated top with power</p>	<b>AM3LMP-2460</b>	24	60	29	\$4,738	+593
	<b>AM3LMP-2466</b>	24	66	29	\$4,767	+593
	<b>AM3LMP-2472</b>	24	72	29	\$4,796	+593
	<b>AM3LMP-3060</b>	30	60	29	\$4,891	+593
	<b>AM3LMP-3066</b>	30	66	29	\$4,918	+593
	<b>AM3LMP-3072</b>	30	72	29	\$4,953	+593
	<b>AM3LMP-3078</b>	30	78	29	\$4,982	+593
	<b>AM3LMP-3084</b>	30	84	29	\$5,012	+593
	<b>AM3LMP-3672</b>	36	72	29	\$5,026	+593
	<b>AM3LMP-3678</b>	36	78	29	\$5,063	+593
	<b>AM3LMP-3684</b>	36	84	29	\$5,093	+593

Top..... 1 1/8" thick laminate top with (ECE) PVC eased edge detail

Base ..... metal

Corners..... mitered

Casters ..... soft or hard, black

**Note:** Flex tables come pre-drilled for modesty panels and ganging brackets. Specify ganging brackets and modesty panels separately.

Table includes one power module and one jumper cable.

### Specify

Edge (available in ECE only)

Base

Power

Casters

Laminate

	Product Number	Depth	Width	Height	Basic Price	Base
<b>MP • Trapezoid</b> plain wood top  	<b>AMZWMN-2160</b>	21	60	29	\$4,970	+593
	<b>AMZWMN-2172</b>	21	72	29	\$5,093	+593
	<b>AMZWMN-2660</b>	26	60	29	\$5,119	+593
	<b>AMZWMN-2672</b>	26	72	29	\$5,198	+593
	<b>AMZWMN-3160</b>	31	60	29	\$5,229	+593
	<b>AMZWMN-3172</b>	31	72	29	\$4,560	+593

*Top.....1 1/4" thick wood veneered with WE3 eased edge detail*  
*Base .....metal*  
*Corners.....mitered*  
*Casters .....soft or hard, black*

**Note:** Flex tables come pre-drilled for modesty panels and ganging brackets.  
 Specify ganging brackets and modesty panels separately.

### Specify

- Wood
- Edge (available in WE3 only)
- Base
- Casters

# MP Flex Tables

Trapezoid • Laminate Top

# GEIGER

	Product Number	Depth	Width	Height	Basic Price	Base
<b>MP • Trapezoid</b> plain laminate top  	<b>AMZLMN-2160</b>	21	60	29	\$4,474	+593
	<b>AMZLMN-2172</b>	21	72	29	\$4,596	+593
	<b>AMZLMN-2660</b>	26	60	29	\$4,624	+593
	<b>AMZLMN-2672</b>	26	72	29	\$4,704	+593
	<b>AMZLMN-3160</b>	31	60	29	\$4,731	+593
	<b>AMZLMN-3172</b>	31	72	29	\$4,064	+593

Top..... 1 1/8" thick laminate top with (ECE) PVC eased edge detail

Base ..... metal

Corners..... mitered

Casters ..... soft or hard, black

**Note:** Flex tables come pre-drilled for modesty panels and ganging brackets. Specify ganging brackets and modesty panels separately.

### Specify

Edge (available in ECE only)

Base

Casters

Laminate

	Product Number	Depth	Width	Height	Basic Price	Base
<b>MP • Trapezoid</b> wood top with large grommet  	<b>AMZWMG-2160</b>	21	60	29	\$5,163	+593
	<b>AMZWMG-2172</b>	21	72	29	\$5,284	+593
	<b>AMZWMG-2660</b>	26	60	29	\$5,314	+593
	<b>AMZWMG-2672</b>	26	72	29	\$5,386	+593
	<b>AMZWMG-3160</b>	31	60	29	\$5,422	+593
	<b>AMZWMG-3172</b>	31	72	29	\$4,941	+593

Top.....1 1/4" thick wood veneered with WE3 eased edge detail  
 Base .....metal  
 Corners.....mitered  
 Casters .....soft or hard, black

**Note:** Flex tables come pre-drilled for modesty panels and ganging brackets.  
 Specify ganging brackets and modesty panels separately.

**Specify**

- Wood
- Edge (available in WE3 only)
- Metal (grommet finish)
- Base
- Casters

# MP Flex Tables

Trapezoid • Laminate Top with Grommet

# GEIGER

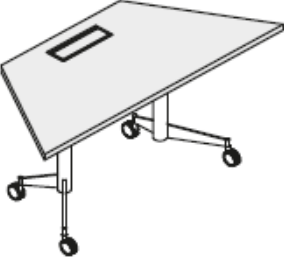
	Product Number	Depth	Width	Height	Basic Price	Base
	<b>MP • Trapezoid</b>					
	laminated top with large grommet					
	<b>AMZLMG-2160</b>	21	60	29	\$4,444	+593
	<b>AMZLMG-2172</b>	21	72	29	\$4,474	+593
	<b>AMZLMG-2660</b>	26	60	29	\$4,596	+593
	<b>AMZLMG-2672</b>	26	72	29	\$4,624	+593
	<b>AMZLMG-3160</b>	31	60	29	\$4,704	+593
	<b>AMZLMG-3172</b>	31	72	29	\$4,731	+593

Top..... 1 1/8" thick laminate top with (ECE) PVC eased edge detail  
 Base ..... metal  
 Corners..... mitered  
 Casters ..... soft or hard, black

**Note:** Flex tables come pre-drilled for modesty panels and ganging brackets. Specify ganging brackets and modesty panels separately.

## Specify

- Edge (available in ECE only)
- Metal (grommet finish)
- Base
- Casters
- Laminate



	Product Number	Depth	Width	Height	Basic Price	Base
<b>MP • Trapezoid</b> wood top with power  	<b>AMZWMP-2160</b>	21	60	29	\$5,624	+593
	<b>AMZWMP-2172</b>	21	72	29	\$5,658	+593
	<b>AMZWMP-2660</b>	26	60	29	\$5,632	+593
	<b>AMZWMP-2672</b>	26	72	29	\$5,808	+593
	<b>AMZWMP-3160</b>	31	60	29	\$5,882	+593
	<b>AMZWMP-3172</b>	31	72	29	\$5,911	+593

Top.....1 1/4" thick wood veneered with WE3 eased edge detail  
 Base .....metal  
 Corners.....mitered  
 Casters .....soft or hard, black

**Note:** Flex tables come pre-drilled for modesty panels and ganging brackets.  
 Specify ganging brackets and modesty panels separately.

Table includes one power module and one jumper cable.

### Specify

- Wood
- Edge (available in WE3 only)
- Base
- Power
- Casters

# MP Flex Tables

Trapezoid • Laminate Top with Power

# GEIGER

	Product Number	Depth	Width	Height	Basic Price	Base
 <p><b>MP • Trapezoid</b> laminated top with power</p>	<b>AMZLMP-2160</b>	21	60	29	\$5,127	+593
	<b>AMZLMP-2172</b>	21	72	29	\$5,163	+593
	<b>AMZLMP-2660</b>	26	60	29	\$5,284	+593
	<b>AMZLMP-2672</b>	26	72	29	\$5,314	+593
	<b>AMZLMP-3160</b>	31	60	29	\$5,384	+593
	<b>AMZLMP-3172</b>	31	72	29	\$5,422	+593

Top..... 1 1/8" thick laminate top with (ECE) PVC eased edge detail  
 Base ..... metal  
 Corners..... mitered  
 Casters ..... soft or hard, black

**Note:** Flex tables come pre-drilled for modesty panels and ganging brackets. Specify ganging brackets and modesty panels separately.

Table includes one power module and one jumper cable.

## Specify

- Edge (available in ECE only)
- Base
- Power
- Casters
- Laminate

	Product Number	Depth	Width	Height	Basic Price	Base
<b>MP • Half Round</b> plain wood top	<b>AMHWMN-48</b>	24	48	29	\$4,489	+593
	<b>AMHWMN-60</b>	30	60	29	\$4,516	+593
	<b>AMHWMN-72</b>	36	72	29	\$4,549	+593



Top.....1 1/4" thick wood veneered with WE3 eased edge detail  
 Base .....metal  
 Casters .....soft or hard, black

**Note:** Flex tables come pre-drilled for modesty panels and ganging brackets.  
 Specify ganging brackets and modesty panels separately.

**Specify**

- Wood
- Edge (available in WE3 only)
- Base
- Casters

# MP Flex Tables

Half Round • Laminate Top

# GEIGER

	Product Number	Depth	Width	Height	Basic Price	Base
MP • Half Round plain laminate top	AMHLMN-48	24	48	29	\$3,992	+593
	AMHLMN-60	30	60	29	\$4,021	+593
	AMHLMN-72	36	72	29	\$4,056	+593



Top..... 1 1/8" thick laminate top with (ECE) PVC eased edge detail

Base .....metal

Casters ..... soft or hard, black

**Note:** Flex tables come pre-drilled for modesty panels and ganging brackets. Specify ganging brackets and modesty panels separately.

## Specify

Edge (available in ECE only)

Base

Casters

Laminate

	Product Number	Depth	Width	Height	Basic Price	Base
<b>MP • Half Round</b> wood top with large grommet	<b>AMHWMG-48</b>	24	48	29	\$4,868	+593
	<b>AMHWMG-60</b>	30	60	29	\$4,897	+593
	<b>AMHWMG-72</b>	36	72	29	\$4,931	+593



Top.....1 1/4" thick wood veneered with WE3 eased edge detail  
 Base .....metal  
 Casters .....soft or hard, black

**Note:** Flex tables come pre-drilled for modesty panels and ganging brackets.  
 Specify ganging brackets and modesty panels separately.

**Specify**

- Wood
- Edge (available in WE3 only)
- Metal (grommet finish) Base
- Casters

# MP Flex Tables

Half Round • Laminate Top with Grommet

# GEIGER

	Product Number	Depth	Width	Height	Basic Price	Base
<b>MP • Half Round</b> laminite top with large grommet	<b>AMHLMG-48</b>	24	48	29	\$4,372	+593
	<b>AMHLMG-60</b>	30	60	29	\$4,400	+593
	<b>AMHLMG-72</b>	36	72	29	\$4,439	+593



Top..... 1 1/8" thick laminate top with (ECE) PVC eased edge detail

Base ..... metal

Casters ..... soft or hard, black

**Note:** Flex tables come pre-drilled for modesty panels and ganging brackets. Specify ganging brackets and modesty panels separately.

## Specify

- Edge (available in ECE only)
- Metal (grommet finish)
- Base
- Casters
- Laminate

	Product Number	Depth	Width	Height	Basic Price	Base
<b>MP • Half Round</b> wood top with power	<b>AMHWMP-48</b>	24	48	29	\$5,556	+593
	<b>AMHWMP-60</b>	30	60	29	\$5,587	+593
	<b>AMHWMP-72</b>	36	72	29	\$5,614	+593



Top.....1 1/4" thick wood veneered with WE3 eased edge detail  
 Base .....metal  
 Casters .....soft or hard, black

**Note:** Flex tables come pre-drilled for modesty panels and ganging brackets.  
 Specify ganging brackets and modesty panels separately.

Table includes one power module and one jumper cable.

**Specify**

- Wood
- Edge (available in WE3 only)
- Base
- Power
- Casters

# MP Flex Tables

Half Round • Laminate Top with Power

# GEIGER

	Product Number	Depth	Width	Height	Basic Price	Base
MP • Half Round laminite top with power	AMHLMP-48	24	48	29	\$5,063	+593
	AMHLMP-60	30	60	29	\$5,093	+593
	AMHLMP-72	36	72	29	\$5,119	+593



Top..... 1 1/8" thick laminate top with (ECE) PVC eased edge detail  
 Base ..... metal  
 Casters ..... soft or hard, black

**Note:** Flex tables come pre-drilled for modesty panels and ganging brackets.  
 Specify ganging brackets and modesty panels separately.

Table includes one power module and one jumper cable.

## Specify

- Edge (available in ECE only)
- Base
- Power
- Casters
- Laminate



	Product Number	Depth	Width	Height	Basic Price	Base
<b>MP • Video Conf. End Table</b> plain wood top	<b>AMVWMN-48</b>	24	48	29	\$4,681	+593
	<b>AMVWMN-60</b>	30	60	29	\$4,710	+593
	<b>AMVWMN-72</b>	36	72	29	\$4,738	+593



Top.....1 1/4" thick wood veneered with WE3 eased edge detail  
 Base .....metal  
 Casters .....soft or hard, black

**Note:** Flex tables come pre-drilled for modesty panels and ganging brackets. Specify ganging brackets and modesty panels separately.

**Specify**

- Wood
- Edge (available in WE3 only)
- Base
- Casters

# MP Flex Tables

Video Conference End Table • Laminate Top

# GEIGER

	Product Number	Depth	Width	Height	Basic Price	Base
<b>MP • Video Conf. End Table</b> plain laminate top	<b>AMVLMN-48</b>	24	48	29	\$4,186	+593
	<b>AMVLMN-60</b>	30	60	29	\$4,212	+593
	<b>AMVLMN-72</b>	36	72	29	\$4,242	+593



*Top..... 1 1/8" thick laminate top with (ECE) PVC eased edge detail*

*Base .....metal*

*Casters ..... soft or hard, black*

**Note:** Flex tables come pre-drilled for modesty panels and ganging brackets. Specify ganging brackets and modesty panels separately.

## Specify

Edge (available in ECE only)

Base

Casters

Laminate

	Product Number	Depth	Width	Height	Basic Price	Base
<b>MP • Video Conf. End Table</b> wood top with large grommet	<b>AMVWMG-48</b>	24	48	29	\$5,063	+593
	<b>AMVWMG-60</b>	30	60	29	\$5,093	+593
	<b>AMVWMG-72</b>	36	72	29	\$5,119	+593



Top.....1 1/4" thick wood veneered with WE3 eased edge detail  
 Base .....metal  
 Casters .....soft or hard, black

**Note:** Flex tables come pre-drilled for modesty panels and ganging brackets.  
 Specify ganging brackets and modesty panels separately.

**Specify**

- Wood
- Edge (available in WE3 only)
- Metal (grommet finish) Base
- Casters

# MP Flex Tables

Video Conference End Table • Laminate Top with Grommet

# GEIGER

	Product Number	Depth	Width	Height	Basic Price	Base
<b>MP • Video Conf. End Table</b> laminite top with large grommet	<b>AMVLMG-48</b>	24	48	29	\$4,568	+593
	<b>AMVLMG-60</b>	30	60	29	\$4,596	+593
	<b>AMVLMG-72</b>	36	72	29	\$4,624	+593



Top..... 1 1/8" thick laminate top with (ECE) PVC eased edge detail

Base .....metal

Casters ..... soft or hard, black

**Note:** Flex tables come pre-drilled for modesty panels and ganging brackets. Specify ganging brackets and modesty panels separately.

## Specify

Edge (available in ECE only)

Metal (grommet finish)

Base

Casters

Laminate

	Product Number	Depth	Width	Height	Basic Price	Base
<b>MP • Video Conf. End Table</b> wood top with power	<b>AMVWMP-48</b>	24	48	29	\$5,743	+593
	<b>AMVWMP-60</b>	30	60	29	\$5,773	+593
	<b>AMVWMP-72</b>	36	72	29	\$5,808	+593



Top.....1 1/4" thick wood veneered with WE3 eased edge detail  
 Base .....metal  
 Casters .....soft or hard, black

**Note:** Flex tables come pre-drilled for modesty panels and ganging brackets.  
 Specify ganging brackets and modesty panels separately.

Table includes one power module and one jumper cable.

**Specify**

- Wood
- Edge (available in WE3 only)
- Base
- Power
- Casters

# MP Flex Tables

Video Conference End Table • Laminate Top with Power

# GEIGER

	Product Number	Depth	Width	Height	Basic Price	Base
<b>MP • Video Conf. End Table</b> laminite top with power	<b>AMVLMP-48</b>	24	48	29	\$5,246	+593
	<b>AMVLMP-60</b>	30	60	29	\$5,284	+593
	<b>AMVLMP-72</b>	36	72	29	\$5,314	+593



Top..... 1 1/8" thick laminate top with (ECE) PVC eased edge detail  
 Base ..... metal  
 Casters ..... soft or hard, black

**Note:** Flex tables come pre-drilled for modesty panels and ganging brackets.  
 Specify ganging brackets and modesty panels separately.

Table includes one power module and one jumper cable.

## Specify

- Edge (available in ECE only)
- Base
- Power
- Casters
- Laminate

	Product Number	Depth	Width	Height	Basic Price
<b>MP • Modesty Panel</b> wood 	<b>AMMWM-24</b>	3/4	23 1/2	7 1/2	\$976
	<b>AMMWM-30</b>	3/4	29 1/2	7 1/2	\$989
	<b>AMMWM-36</b>	3/4	35 1/2	7 1/2	\$1,003
	<b>AMMWM-42</b>	3/4	41 1/2	7 1/2	\$1,018
	<b>AMMWM-48</b>	3/4	47 1/2	7 1/2	\$1,032
	<b>AMMWM-60</b>	3/4	59 1/2	7 1/2	\$1,046
	<b>AMMWM-66</b>	3/4	65 1/2	7 1/2	\$1,068
	<b>AMMWM-72</b>	3/4	71 1/2	7 1/2	\$1,082
	<b>AMMWM-78</b>	3/4	77 1/2	7 1/2	\$1,097
	<b>AMMWM-84</b>	3/4	83 1/2	7 1/2	\$1,112

**Specify**  
 Wood

# MP Flex Tables

Modesty Panel • Laminate

# GEIGER

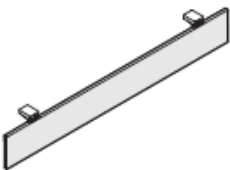
	Product Number	Depth	Width	Height	Basic Price
<b>MP • Modesty Panel</b> laminate 	<b>AMMLM-24</b>	3/4	23 1/2	7 1/2	\$826
	<b>AMMLM-30</b>	3/4	29 1/2	7 1/2	\$837
	<b>AMMLM-36</b>	3/4	35 1/2	7 1/2	\$852
	<b>AMMLM-42</b>	3/4	41 1/2	7 1/2	\$865
	<b>AMMLM-48</b>	3/4	47 1/2	7 1/2	\$882
	<b>AMMLM-60</b>	3/4	59 1/2	7 1/2	\$896
	<b>AMMLM-66</b>	3/4	65 1/2	7 1/2	\$910
	<b>AMMLM-72</b>	3/4	71 1/2	7 1/2	\$931
	<b>AMMLM-78</b>	3/4	77 1/2	7 1/2	\$947
	<b>AMMLM-84</b>	3/4	83 1/2	7 1/2	\$960

**Specify**

Laminate



	Product Number	Depth	Width	Height	Basic Price
<b>MP • Rounded Corner</b> wood	<b>AMCWMN-2424</b>	24	24	1 1/4	\$1,871
	<b>AMCWMN-3030</b>	30	30	1 1/4	\$1,964
	<b>AMCWMN-3636</b>	36	36	1 1/4	\$2,073

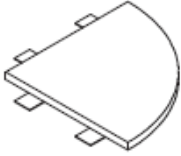

*Note: Rounded corner does not include power jumper cable.  
Specify **AMPPJ-12** for 24" or 30" rounded corners and **AMPPJ-24** for 36" rounded corners.*

### Specify

Wood  
Edge (available in LVS only)

# MP Flex Tables

Rounded Corner • Laminate

GEIGER

	Product Number	Depth	Width	Height	Basic Price
<b>MP • Rounded Corner laminate</b>	<b>AMCLMN-2424</b>	24	24	1 1/8	\$1,578
	<b>AMCLMN-3030</b>	30	30	1 1/8	\$1,665
	<b>AMCLMN-3636</b>	36	36	1 1/8	\$1,772

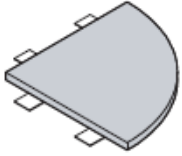

*Note: Rounded corner does not include power jumper cable.  
Specify **AMPPJ-12** for 24" or 30" rounded corners and **AMPPJ-24** for 36" rounded corners.*

**Specify**

Edge (available in ECE only)  
Laminate

	Product Number	Basic Price
<b>MP • Ganging Hardware</b> For MP Flex Tables	<b>AMGM-1</b>	\$119

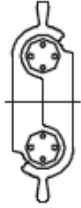

*Note: Order one ganging kit for each side connection and two ganging kits for each back to back connection.*

*All rectangular, trapezoid and half-round tables are pre-drilled to accept ganging brackets.*

**Specify**

# MP Flex Tables

## Jumper Cables

# GEIGER

	Product Number	Basic Price
<b>MP • Jumper Cables</b> For MP Flex Tables 	<i>MP Flex, Power, Interlink IQ 2.0 By-Pass Jumper Cable</i>	
	<b>AMPPJ-12N</b>	\$148
	<b>AMPPJ-24N</b>	\$148
	<b>AMPPJ-36N</b>	\$148
	<b>AMPPJ-48N</b>	\$148
	<b>AMPPJ-60N</b>	\$148

*Note: multiple jumper cables may be required depending on width of table*

**Specify**

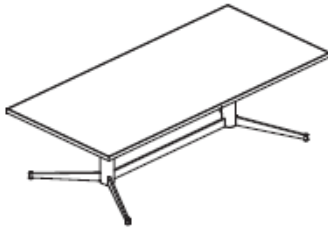
	Product Number	Depth	Width	Basic Price	Base
<b>MP Height Adjustable</b> rectangular with wood top  	<i>1 1/4" wood top</i>				
	<b>AM3HWA-3060</b>	30	60	\$7,547	+1,082
	<b>AM3HWA-3066</b>	30	66	\$7,677	+1,082
	<b>AM3HWA-3072</b>	30	72	\$7,800	+1,082
	<b>AM3HWB-3660</b>	36	60	\$7,800	+1,082
	<b>AM3HWB-3666</b>	36	66	\$7,991	+1,082
	<b>AM3HWB-3672</b>	36	72	\$8,123	+1,082
	<b>AM3HWB-3678</b>	36	78	\$8,266	+1,082
	<b>AM3HWB-3684</b>	36	84	\$8,473	+1,082
	<b>AM3HWB-4278</b>	42	78	\$8,595	+1,082
	<b>AM3HWB-4284</b>	42	84	\$8,833	+1,082
	<b>AM3HWB-4290</b>	42	90	\$9,005	+1,082
	<b>AM3HWB-4296</b>	42	96	\$9,186	+1,082
	<b>AM3HWB-4884</b>	48	84	\$9,186	+1,082
	<b>AM3HWB-4890</b>	48	90	\$9,379	+1,082
	<b>AM3HWB-4896</b>	48	96	\$9,580	+1,082

Top.....wood veneered with specified edge detail  
 Base .....metal with black top

### Specify

Wood  
 Edge  
 Base  
 Plug Strip

Table adjustable height range is 27" to 52-1/2".  
 Table includes one plug-in or hardwired under-table plug strip.

# MP Height Adjustable Tables

Rectangular • Glass Top

# GEIGER

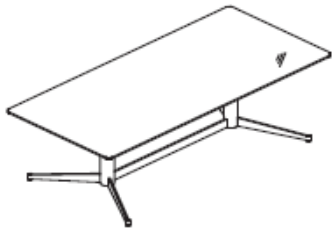
	Product Number	Depth	Width	Basic Price	Base
<b>MP Height Adjustable</b> rectangular with glass top  	<i>Glass top</i>				
	<b>AM3HBB-3060</b>	30	60	\$9,423	+1,082
	<b>AM3HBB-3066</b>	30	66	\$9,672	+1,082
	<b>AM3HBB-3072</b>	30	72	\$9,934	+1,082
	<b>AM3HBB-3660</b>	36	60	\$9,934	+1,082
	<b>AM3HBB-3666</b>	36	66	\$10,270	+1,082
	<b>AM3HBB-3672</b>	36	72	\$10,551	+1,082

Top..... 1/2" thick with polished flat edge and a 3/4" thick painted sub top  
 Base .....metal with black top

## Specify

Glass Table adjustable height range is 27" to 52-1/2".  
 Paint Table includes one plug-in or hardwired under-table plug strip.  
 Base  
 Plug Strip

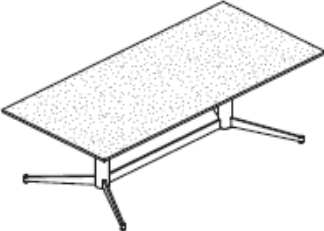
	Product Number	Depth	Width	Basic Price	Base
<b>MP Height Adjustable</b> rectangular with marble top  	<i>marble/stone top</i>				
	<b>AM3HSB-3060</b>	30	60	\$14,437	+1,082
	<b>AM3HSB-3066</b>	30	66	\$15,193	+1,082
	<b>AM3HSB-3072</b>	30	72	\$15,944	+1,082
	<b>AM3HSB-3660</b>	36	60	\$15,944	+1,082
	<b>AM3HSB-3666</b>	36	66	\$16,902	+1,082
	<b>AM3HSB-3672</b>	36	72	\$17,782	+1,082

*Top.....3/4" marble/stone top with eased edge and 3/4" painted subtop*  
*Base .....metal with black top*

### Specify

Stone  
 Paint  
 Base  
 Plug Strip

Table adjustable height range is 27" to 52-1/2".  
 Table includes one plug-in or hardwired under-table plug strip.

# MP Height Adjustable Tables

Oblong MP Height Adjustable

# GEIGER

	Product Number	Depth	Width	Basic Price	Base
<b>MP Height Adjustable</b> oblong with wood top  	<i>1 1/4" wood top</i>				
	<b>AM5HWB-4278</b>	42	78	\$8,582	+1,082
	<b>AM5HWB-4284</b>	42	84	\$8,754	+1,082
	<b>AM5HWB-4290</b>	42	90	\$8,933	+1,082
	<b>AM5HWB-4884</b>	48	84	\$9,108	+1,082
	<b>AM5HWB-4890</b>	48	90	\$9,363	+1,082
	<b>AM5HWB-4896</b>	48	96	\$9,566	+1,082

*Top.....wood veneered with specified edge detail*  
*Base .....metal with black top*

## Specify

Wood  
 Edge  
 Base  
 Plug Strip

Table adjustable height range is 27" to 52-1/2".  
 Table includes one plug-in or hardwired under-table plug strip.

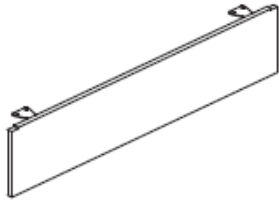
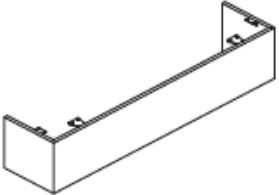

	Product Number	Depth	Width	Height	Basic Price
<b>MP • Modesty Panel</b> wood or painted 	<i>wood, vertical grain</i>				
	<b>AMMHV-5612</b>	3/4	55 3/4	12 1/4	\$936
	<b>AMMHV-6812</b>	3/4	67 3/4	12 1/4	\$1,053
	<i>painted</i>				
	<b>AMMHP-5612</b>	3/4	55 3/4	12 1/4	\$826
	<b>AMMHP-6812</b>	3/4	67 3/4	12 1/4	\$882
<b>MP • Modesty U Panel</b> wood or painted 	<i>wood, vertical grain</i>				
	<b>AMMHVU-5612</b>	3/4	55 3/4	12 1/4	\$1,384
	<b>AMMHVU-6812</b>	3/4	67 3/4	12 1/4	\$1,506
	<i>painted</i>				
	<b>AMMHPU-5612</b>	3/4	55 3/4	12 1/4	\$1,277
	<b>AMMHPU-6812</b>	3/4	67 3/4	12 1/4	\$1,333

### Specify

Wood (for wood products)  
 Paint (for painted products)

<i>Product Number</i>	<i>Page</i>	<i>Product Number</i>	<i>Page</i>	<i>Product Number</i>	<i>Page</i>	<i>Product Number</i>	<i>Page</i>
AM1BB .....	27	AM2WB .....	34	AM3WVG .....	65	AMMHV .....	97
AM1BF .....	23	AM2WD .....	34	AM3WMN .....	63	AMMHVU.....	97
AM1BK .....	25	AM2WF.....	30	AM3WMP .....	67	AMMLM .....	88
AM1BP .....	29	AM2WH .....	30	AM4WF.....	57,58,59	AMMWM.....	87
AM1CC.....	29	AM2WK .....	32	AM5BB .....	56	AMPPJ .....	92
AM1CD.....	27	AM2WM.....	32	AM5BK .....	50	AMVLMG.....	84
AM1CL.....	25	AM2WP .....	36	AM5WB .....	51	AMVLMN.....	82
AM1CO.....	23	AM2WR .....	36	AM5WD .....	52	AMVLMP.....	86
AM1WB .....	26	AM3BB .....	48	AM5WK .....	49	AMVVMG.....	83
AM1WD.....	26	AM3BK .....	41	AM5WM.....	49	AMVVMN.....	81
AM1WF.....	22	AM3CD.....	47	AM8WF.....	53,54,55	AMVWMP.....	85
AM1WH.....	22	AM3CL.....	40	AM9WF.....	60,61,62	AMZLMG.....	72
AM1WK.....	24	AM3HBB.....	94	AMCLMN.....	90	AMZLMN.....	70
AM1WM.....	24	AM3HSB.....	95	AMCWMN.....	89	AMZLMP.....	74
AM1WP.....	28	AM3HWA.....	93	AM5HWB.....	96	AMZWVG.....	71
AM1WR.....	28	AM3HWB.....	93	AMGM .....	91	AMZWVN.....	69
AM2BB .....	35	AM3LMG.....	66	AMHLMG.....	78	AMZWVP.....	73
AM2BF .....	31	AM3LMN.....	64	AMHLMN.....	76		
AM2BK .....	33	AM3LMP.....	68	AMHLMP.....	80		
AM2BP .....	37	AM3WB .....	42	AMHWVG.....	77		
AM2CC.....	37	AM3WD.....	43	AMHVMN.....	75		
AM2CD.....	35	AM3WF.....	44,45,46	AMHWVP.....	79		
AM2CL.....	33	AM3WK .....	38	AMMHP .....	97		
AM2CO.....	31	AM3WM.....	39	AMMHPU.....	97		

**MP™ Tables were designed by Amir Paknya**

© 2018 Geiger International, Inc. All rights reserved.

® Geiger International is a registered trademark of Geiger International, Inc.

™ The Geiger logo, MP Tables, and MP Flex Tables are trademarks of Geiger International, Inc., and/or of its independent designers.